

OPERATION

Mechanical Operation

OPERATING CONDITIONS

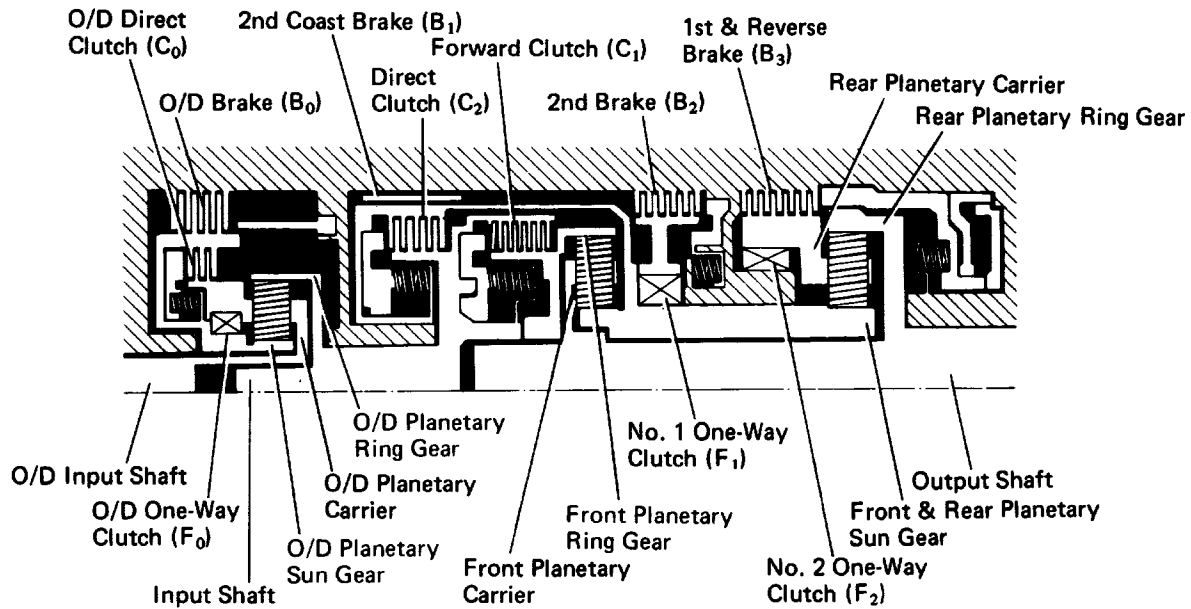

AT2157

○ Operating

| Shift lever position | Gear position | C ₀ | C ₁ | C ₂ | B ₀ | B ₁ | B ₂ | B ₃ | F ₀ | F ₁ | F ₂ |
|----------------------|---------------|----------------|----------------|----------------|----------------|----------------|----------------|----------------|----------------|----------------|----------------|
| P | Parking | ○ | | | | | | | | | |
| R | Reverse | ○ | | ○ | | | | ○ | ○ | | |
| N | Neutral | ○ | | | | | | | | | |
| D | 1 st | ○ | ○ | | | | | | ○ | | ○ |
| | 2nd | ○ | ○ | | | | ○ | | ○ | ○ | |
| | 3rd | ○ | ○ | ○ | | | ○ | | ○ | | |
| | O/D | | ○ | ○ | ○ | | ○ | | | | |
| 2 | 1 st | ○ | ○ | | | | | | ○ | | ○ |
| | 2nd | ○ | ○ | | | ○ | ○ | | ○ | ○ | |
| | 3rd | ○ | ○ | ○ | | | ○ | | ○ | | |
| L | 1 st | ○ | ○ | | | | | ○ | ○ | | ○ |
| | * 2nd | ○ | ○ | | | ○ | ○ | | ○ | ○ | |

* Down-shift only in the L position and 2nd gear—no up-shift.

FUNCTION OF COMPONENTS

| NOMENCLATURE | OPERATION |
|--|--|
| O/D Direct Clutch (C ₀) | Connects overdrive sun gear and overdrive carrier |
| O/D Brake (B ₀) | Prevents overdrive sun gear from turning either clockwise or counterclockwise |
| O/D One-Way Clutch (F ₀) | When transmission is being driven by engine, connects overdrive sun gear and overdrive carrier |
| Forward Clutch (C ₁) | Connects input shaft and front planetary ring gear |
| Direct Clutch (C ₂) | Connects input shaft and front & rear planetary sun gear |
| 2nd Coast Brake (B ₁) | Prevents front & rear planetary sun gear from turning either clockwise or counterclockwise |
| 2nd Brake (B ₂) | Prevents outer race of F, from turning either clockwise or counterclockwise, thus preventing front & rear planetary sun gear from turning counterclockwise |
| 1st & Reverse Brake (B ₃) | Prevents rear planetary carrier from turning either clockwise or counterclockwise |
| No. 1 One-Way Clutch (F ₁) | When B ₂ is operating, prevents front & rear planetary sun gear from turning counterclockwise |
| No.2 One-Way Clutch (F ₂) | Prevents rear planetary carrier from turning counterclockwise |

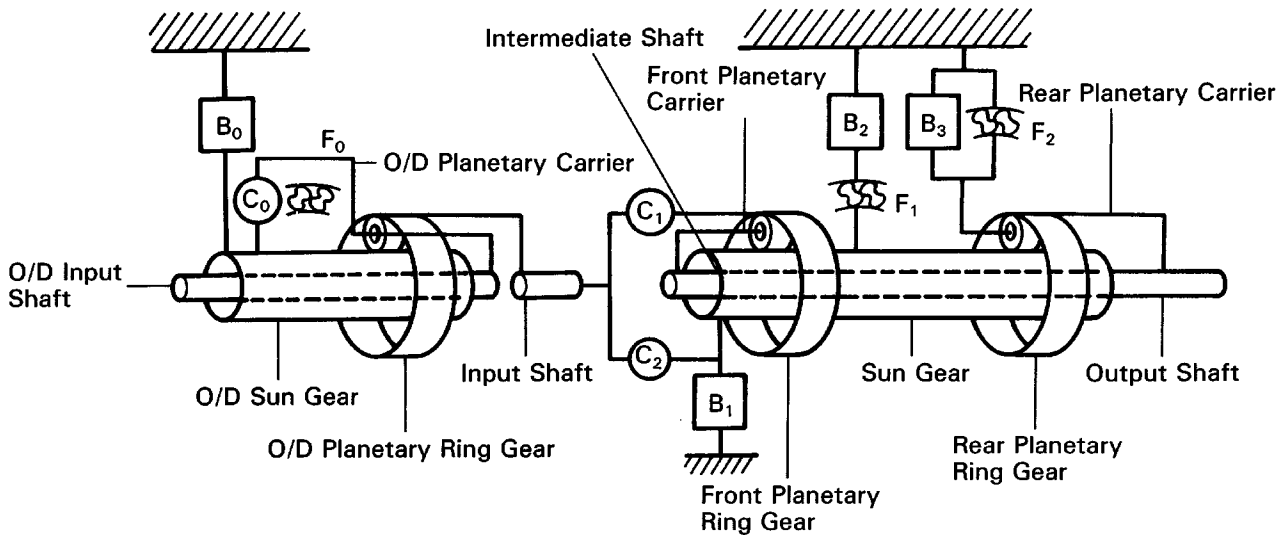

002957

FUNCTION OF COMPONENTS (Cont'd)

The conditions of operation for each gear position are shown in the following illustrations:

D or 2 Position 1st Gear

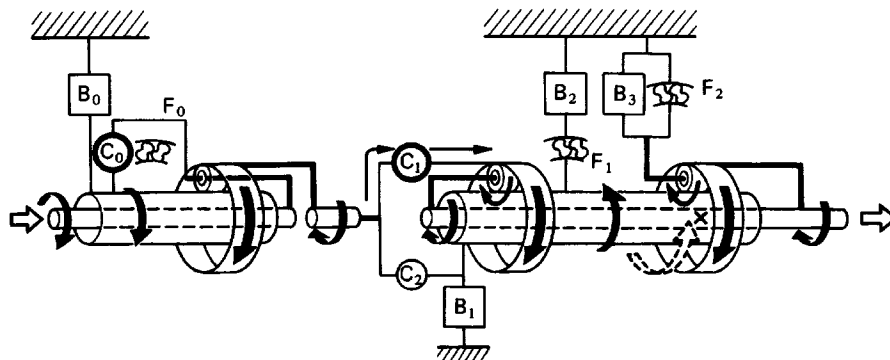

AT6675

D Position 2nd Gear

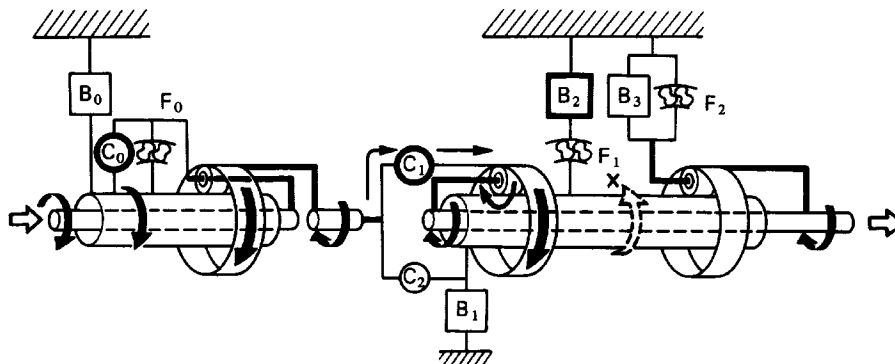

AT6676

D or 2 Position 3rd Gear

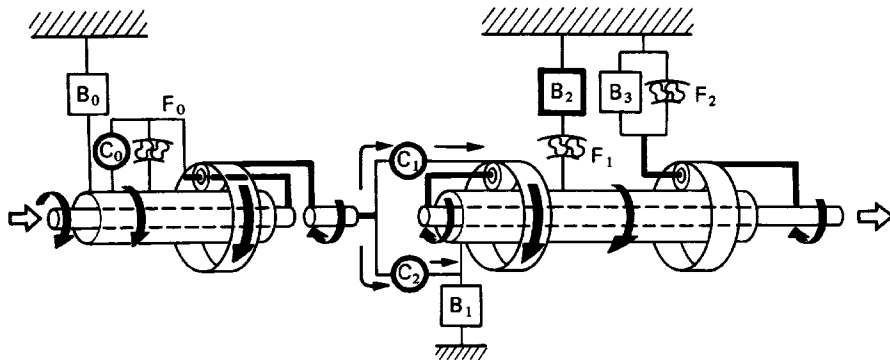

AT6677

D Position O/D

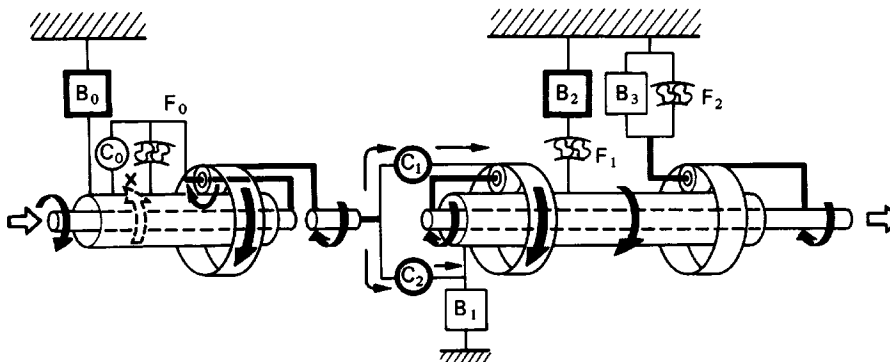

AT6678

FUNCTION OF COMPONENTS (Cont'd)

2 or L Position 2nd Gear

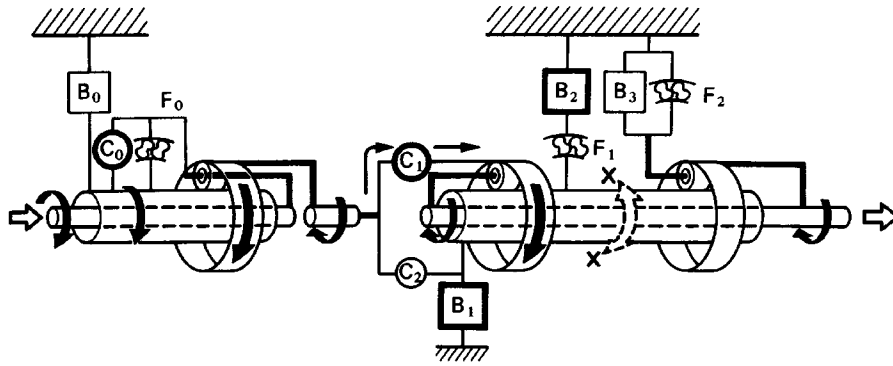

AT6679

L Position 1st Gear

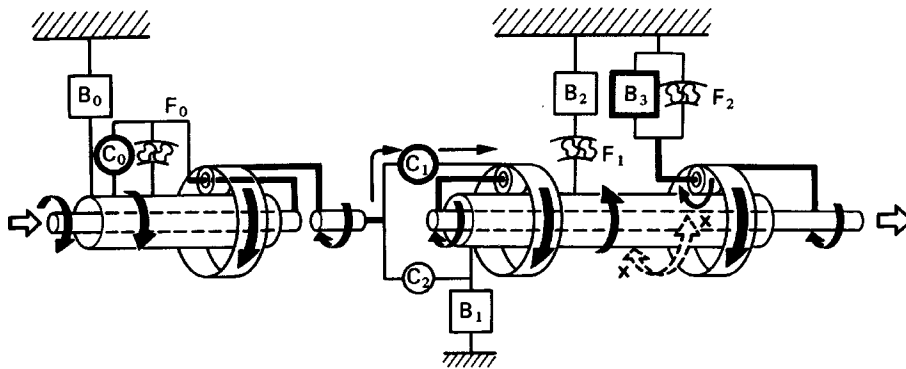

AT6680

R Position Reverse Gear

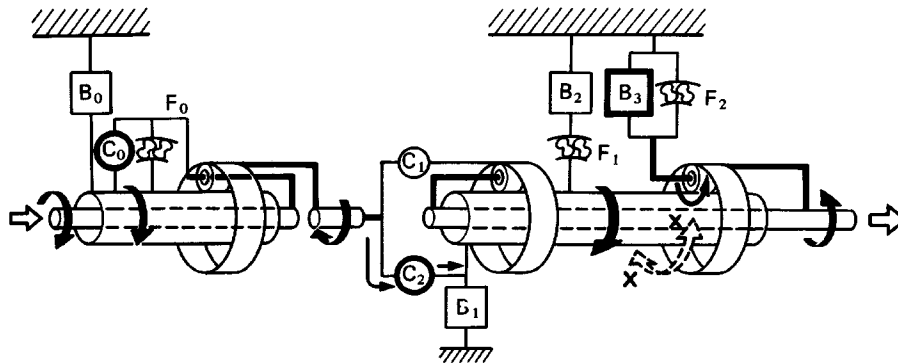

AT6681

HYDRAULIC CONTROL SYSTEM

The hydraulic control system is composed of the oil pump, the valve body, the solenoid valves, and the clutches and brakes, as well as the fluid passages which connect all of these components. Based on the hydraulic pressure created by the oil pump, the hydraulic control system governs the hydraulic pressure acting on the torque converter clutch, clutches and brakes in accordance with the vehicle driving conditions.

There are three solenoid valves on the valve body. These solenoid valves are turned on and off by signals from the ECM to operate the shift valves. These shift valves then switch the fluid passages so that fluid goes to the torque converter clutch and planetary gear units.

(Except for the solenoid valves, the hydraulic control system of the electronic controlled transmission is basically the same as that of the fully hydraulic controlled automatic transmission.)

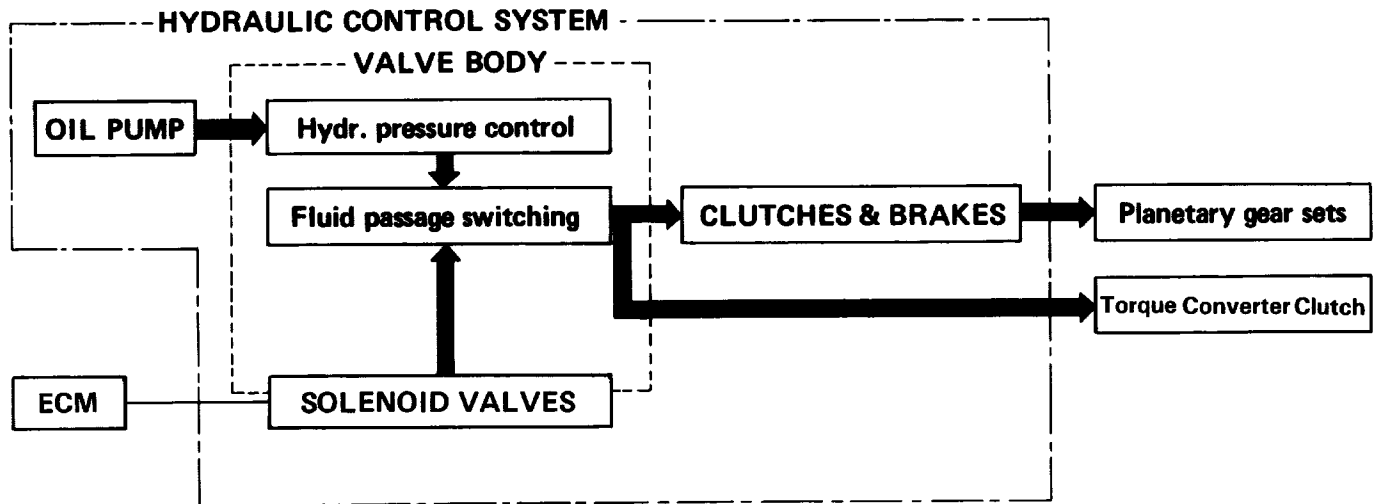

- **LINE PRESSURE**

Line pressure is the most basic and important pressure used in the automatic transmission, because it is used to operate all of the clutches and brakes in the transmission.

If the primary regulator valve does not operate correctly, line pressure will be either too high or too low. Line pressure that is too high will lead to shifting shock and consequent engine power loss due to the greater effort required of the oil pump; line pressure that is too low will cause slippage of clutches and brakes, which will, in extreme cases, prevent the vehicle from moving. Therefore, if either of these problems are noted, the line pressure should be measured to see if it is within standard.

- **THROTTLE PRESSURE**

Throttle pressure is always kept in accordance with the opening angle of the engine throttle valve. This throttle pressure acts on the primary regulator valve and, accordingly, line pressure is regulated in response to the throttle valve opening.

In the fully hydraulic controlled automatic transmission, throttle pressure is used for regulating line

- Pressure and as signal pressure for up-shift and down-shift of the transmission. In the electronic
- controlled transmission, however, throttle pressure is used only for regulating line pressure. Consequently, improper adjustment of the transmission throttle cable may result in a line pressure that is too high or too low. This, in turn, will lead to shifting shock or clutch and brake slippage.

ELECTRONIC CONTROL SYSTEM

The electronic control system, which controls the shift points and the operation of the lock-up clutch, is composed of the following three parts:

1. Sensors

These sensors sense the vehicle speed, throttle opening and other conditions and send these data to the ECM in the form of electrical signals.

2. ECM

The ECM determines the shift and lock-up timing based upon the signals from sensors, and controls the solenoid valves of the hydraulic control unit accordingly.

3. Actuators

These are three solenoid valves that control hydraulic pressure acting on the hydraulic valves to control shifting and lock-up timing.

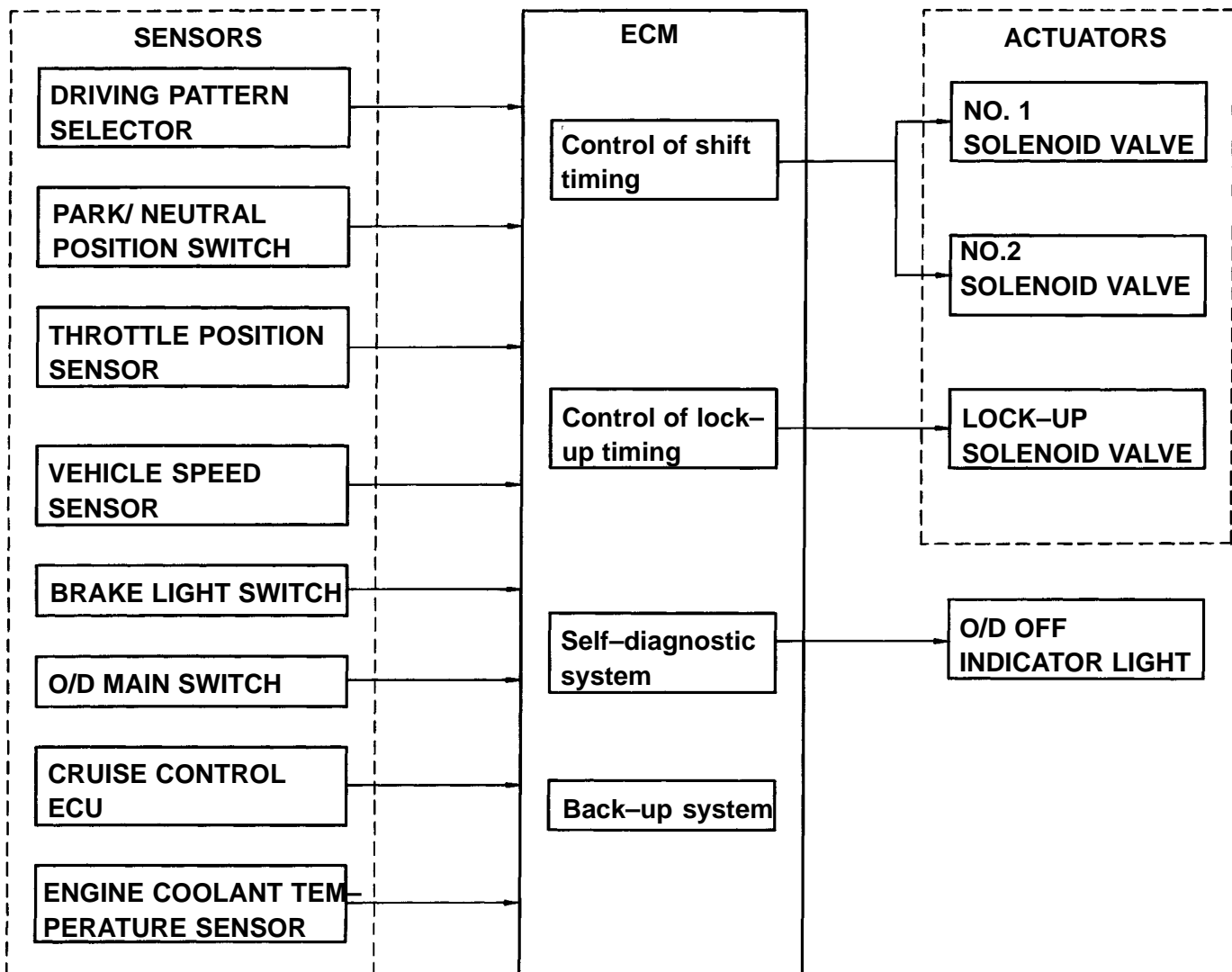

FUNCTION OF ECM

• Control of Shift Timing

The ECM has programmed into its memory the optimum shift pattern for each shift lever position (D, 2, L position) and driving mode (Normal or Power).

Based on the appropriate shift pattern, the ECM turns No. 1 and No.2 solenoid valves on or off in accordance with the vehicle speed signal from the vehicle speed sensor and the throttle opening signal from the throttle position sensor. In this manner, the ECM operates each shift valve, opening or closing the fluid passages to the clutches and brakes to permit up-shift or down-shift of the transmission.

HINT: The electronic control system provides shift timing and lock-up control only while the vehicle is traveling forward. In REVERSE, PARK, and NEUTRAL, the transmission is mechanically, not electronically controlled.

• Control of Overdrive

Driving in overdrive is possible if the O/D main switch is on and the shift lever is in the D position. However, when the vehicle is being driven using the cruise control system (CCS), if the actual vehicle speed drops to about 4 km/h (2 mph) below the set speed while the vehicle is running in overdrive, the CCS ECU sends a signal to the ECM to release the overdrive and prevent the transmission from shifting back into overdrive until the actual vehicle speed reaches the speed set in the CCS memory.

On this model, if the engine coolant temperature falls below 70°C (158°F), preventing the transmission from up-shifting into overdrive.

• Control of Lock-Up System

The ECM has programmed in its memory a lock-up clutch operation pattern for each driving mode (Normal or Power). Based on this lock-up pattern, the ECM turns lock-up solenoid valve on or off in accordance with the vehicle speed signals received from the vehicle speed sensor and the throttle opening signals from the throttle position sensor.

Depending on whether lock-up solenoid valve is on or off, the lock-up relay valve performs changeover of the fluid passages for the converter pressure acting on the torque converter clutch to engage or disengage the lock-up clutch.

(Mandatory Cancellation of Lock-Up System)

If any of the following conditions exist, the ECM turns off lock-up solenoid valve to disengage the lock-up clutch.

- 1) The brake light switch comes on (during braking).
- 2) The IDL points of the throttle position sensor close (throttle valve fully closed).
- 3) The engine coolant temperature falls below 70°C (158°F).

The purpose of 1) and 2) above is to prevent the engine from stalling if the rear wheels lock up. The purpose of 3) is to cause the torque converter clutch to operate to obtain torque multiplication. The purpose of 4) is both to improve general driveability, and to speed up transmission warm-up.

Also, while the lock-up system is in operation, the ECM will temporarily turn it off during up-shift or down-shift in order to decrease shifting shock.