



# CASWELL

ELECTROPLATING IN MINIATURE

# **The Caswell Plating Manual**

## **Version X**

**Includes**

**Triple Chrome Plating**

**Anodizing**

**Brush Plating**

**Baby Shoe Bronzing**

**Metal Polishing**

THE PRINCIPLES OF PLATING	3
SAFETY PROCEDURES	5
REVERSE OSMOSIS AND PH METER	6
SOME THINGS YOU MIGHT NEED	7
SETTING UP A WORKSHOP	8
HEATING THE PLATING SOLUTIONS	15
WIRING UP THE PARTS	17
THE POWER SOURCE	20
MAKING A NICHROME POWER CONTROLLER	23
REPAIRING PITTED METALS	25
PREPARING YOUR SOLUTIONS	28
STRIPPING AND ETCHING	30
INTRODUCTION TO PLATING PROCEDURES	33
METALS CHART	34
BRIGHT NICKEL & COPY CHROME PLATING	35
ZINCATE INSTRUCTIONS	39
FLASH COPPER PLATING	40
BRIGHT ACID COPPER PLATING	43
BRONZE PLATING	46
DECORATIVE CHROME PLATING	49
GENERAL HARD CHROME PLATING INSTRUCTIONS	52
CHROME PLATING TROUBLESHOOTING	89
BRIGHT ACID TIN PLATING PROCESS	90
BLACK KROME PLATING	92
BRASS PLATING	94
COPY CAD® & ZINC PLATING	96
CHROMATE PROCESSES	101
SILVER TANK PLATING	104
GOLD TANK PLATING	108
STAINLESS STEEL ACTIVATOR FOR GOLD	110
THE LCD ALUMINUM ANODIZING SYSTEM	112
FADE ANODIZING PROCESS	120
BRUSH PLATING WITH PLUG N' PLATE®	128
GOLD EMBLEM PLATING USING PLUG N' PLATE®	129
DIP PLATING WITH PLUG N' PLATE®	130
FASTGOLD	132
ELECTROLESS NICKEL & KROME PLATING	133
BORON NITRIDE ELECTROLESS NICKEL	138
BLACK OXIDIZING OF STEEL	141
RUB ON SILVER PLATING	142
ANTIQUING OXIDIZERS	143
PLATING PLASTICS & NON CONDUCTERS	144
BRONZING BABY SHOES	145
PLATING LEAD, PEWTER AND STAINED GLASS OBJECTS	146
WASTE DISPOSAL	147
TECHNICAL SUPPORT	151
THE WATER BREAK TEST	152
CALCULATING SURFACE AREAS	153

This manual is a reference book. We suggest you read the entire book before proceeding, and then you will need to refer to specific sections depending on the job you are trying to achieve. It would be ideal to be able to write this book in a 1-2-3 step fashion, but there are so many variables, it would be impossible to cover them all.

We've been in the business of supplying small plating kits for many years, and as we progressed, so did our plating manual. This is our NINTH version and represents a radical change in thinking when it comes to the power supply for each plating kit. Now, we are firmly convinced that most problems can be eliminated, and more consistent results achieved if the amateur plater has a better understanding and better control of the power. So, gone are light bulbs, and other cheap methods of power control, gone are the 'rectifiers' that have no constant current control. Our systems now revolve around the new power supplies that give you phenomenal control, making plating simpler and more predictable.

We've taken some items out of the manual, and relegated a few others to the back of the manual, to keep the book more concise and to the point. I'd always like to hear from anyone who has any 'tricks-of-the-trade' they might like to share, or improvements they may think of.

Pictures of your plating set-up, current project, and completed jobs are always welcome. We'll display them on our web page in our 'Restoration Gallery', or you can produce your own 'gallery' in our electroplating forum online. We even want pictures of the jobs that didn't go too well. We're building an online 'troubleshooting' gallery, so customers can look at the sorts of things that go wrong, and find out easily how to rectify them. So, those 'mess-ups' are good for us. Like Thomas Edison said about his failures, "I'm one step closer to success because I know that DOESN'T work". So, please email us your stories and photos to [sales@caswellplating.com](mailto:sales@caswellplating.com)

I am particularly pleased to say that our LCD Anodizing System is without doubt the most advanced system for amateur operators anywhere. The instructions are so much more precise and the results are very consistent and predictable. We have discovered that accurate control of the power brings consistent results, better than most professional anodizers provide.

Our technical support just keeps getting better. Your first line of defense is, of course, the manual. Almost everything you need to know is somewhere in here; just take the time to read it over a few times. Then we have our online technical support at <http://support.caswellplating.com> which logs the problem and records our dialog as we resolve the issue for you.

My favorite is the Online Plating forum, where thousands of our old and new customers get together to swap ideas, and where you get support from your peers. Without a doubt, these guys are good and this is where you'll get most help. If you can't resolve the problem from the manual, then post the question here, before you use our tech support. You'll get several points of view, and find this a fantastic service.

See <http://forum.caswellplating.com> and look for the 'electroplating' forum

There are some great tutorials on the webpage too:

Clip 5 - [The Waterbreak Test](#) – 256k QuickTime

Tutorial 1 - [How To Electroplate](#) (38kb)

Tutorial 3 - [Controlling Power With Bulbs](#) (303kb)

Tutorial 2 - [Setting Up The Plating Tank](#) (172kb)

Tutorial 4 - [Understanding Anode Placement](#) (275kb)

Finally, we have a new 40 minute video on Triple Chrome Plating. This is great value and will teach you the basics very quickly. See <http://www.caswellplating.com/kits/tcvideo.html>. Recently, we have started putting this video in with all Triple Chrome Plating kits.

I hope you enjoy the manual, and good luck plating.

Mike Caswell

## THE PRINCIPLES OF PLATING

Electroplating is the depositing of positively charged metal particles (ions) moving through a solution by electricity, attracting them onto an object that has been given a negative charge.

Using the immersion plating technique, the object to be plated (the cathode) is connected to the negative (-) side of the power supply, giving it the negative charge, and a metal plate usually made of the plating metal (the anode) is connected to the positive (+) side of the power supply, giving it a positive charge.

Positive ions flow from the anode toward the object being plated, through the plating solution (the electrolyte), and are deposited onto the surface of the object. The longer the system is left on, the thicker the resulting plate will be.

Commercial platers usually 'TRIPLE' chrome plate steel in the following manner:-

Strike coat of Cyanide Copper	For bonding
Acid Copper Plate	For hi-build filling
Nickel Plate	For the corrosion resistance
Chrome Plate	For the color and protection of the nickel

The cyanide strike coat is an inexpensive method of providing a fast bond for the Nickel, but as it is only a very thin layer it has to be built up with the acid copper.

Acid copper can plate layers up to 1/4" thick, given time, and as it is a soft metal, it can be polished to give a beautiful luster. This is the stage where the commercial platers spend their time to get the 'show quality chrome' finish we all know.

The Nickel Plate is the hard protective layer, and is really the 'guts' of a chrome plate. It is this nickel you usually see peeling from an old bumper. As this is a hard metal, it is more difficult to polish or burnish, and so it is essential that all blemishes and repairs are done before this plating stage.

Nickel, given time and the elements, will dull down, giving a flat almost leaden look. It can often easily be brought back to life with a little chrome polish, but it is for this reason that chrome is applied.

Decorative Chrome plate is a very thin layer of plate. It can be applied directly to many metals, but it is extremely porous and will allow the part to rust through in next to no time. Only by providing adequate under layers of copper and or nickel, will this be avoided.

Our New Triple Chrome Kit offers a set up similar to the commercial plater, except that we use a strike coat of FLASH COPPER instead of the cyanide copper. FLASH COPPER will bond to almost all the same materials that a cyanide copper plate will. The obvious advantage is that FLASH COPPER is much safer.

Our New Triple Chrome Plate Procedure is:-

FLASH COPPER	15 minutes
Acid Copper Plate	15-30 minutes - only if repairs are needed.
Nickel Plate	30-45 minutes
Chrome Plate	2 - 4 minutes

Often, a nickel plate can be applied without the underlying copper plates. This will work particularly well on steel.

In many situations the nickel plate will be quite adequate, so no further plating will be needed. There are many combinations of plate that can be used. There seems to be no real set rules, except that, if it works, do it! Our most successful customers experiment a little, once they have mastered the basics.

A simpler and effective alternative to real Chrome plating, is to use Copy Chrome. This can be applied directly to steel, copper, brass and bronze, so it will also go over FLASH COPPER. When more difficult metals such as lead and pot metal need to be plated, FLASH COPPER can be applied as the 'primer' and then Copy Chrome applied over.

Brush Plating is a technique which allows you to plate a small area on a part without immersing it in a tank. This is especially useful for doing touch ups, or gold plating, where the solution is expensive.

Electroless Plating is a chemical reaction of the part and the solution, usually heated, which plates the part extremely evenly. This technique is very useful for small parts,

Practice makes Perfect. The best platers keep notes! Recording your successes and failures is the best way of learning, and practice really does make perfect. If it isn't working, you are probably doing something wrong! Check your procedures with the manual and try again. If you can't fathom it out, make a note of what you did and then give post your problem on the forum. You'll get answers there quickly.

We suggest that you start off with some scrap metals for your first efforts. Short lengths of copper pipe are great for practicing on. Save each piece so that you can apply another plate to it when you set up the next tank.

Try some different finishes like wire brushing, emery sanding, bead blasting or buffing and polishing. Practice your buffing skills on these bits of pipe, then plate all of them! You will immediately discover the benefits of good preparation, and then understand that 'show quality finishes' have little to do with the actual plating. It's all in the prep

Your first plating job can be plating your tank bars. A good nickel plate applied to these copper pipes will dramatically reduce any corrosion forming on them.

**You should start off using ONLY ONE KIT AT A TIME.** If, for example, you have a TRIPLE CHROME KIT, don't set up all the tanks, because you'll be tempted to flit amongst the processes. It is imperative that you master ONE SKILL at a time. DO NOT progress to another kit until you are quite satisfied you are producing good plating.

We suggest, that with a Triple Chrome kit, you set up the nickel tank first and learn that process. Once mastered, the other kits will be much easier to understand.

Select some pieces of ½" diameter copper pipe, cut them to 5" lengths, this will give you a total surface area of 8 square inches. By learning to plate using these items, you'll have a constant sized product to practise on.

For most plating setups, the requirement is 1 amp per 16 sq inches, so you'll need ½ an amp to plate these pipes. When chroming, you'll need 1 amp per sq inch, or 8 amps for these pipes.

Try different finishes, sand blasting, polished, wire brushed, just dirty, etc. and see what they come out like. Buff the finish vigorously, to see it improve (hopefully) and to see if it is well bonded.

Try plating over the nickel plated pipe with copper.

Experiment until you get a satisfactory result.

## **SAFETY PROCEDURES**

The major problem with any larger plating operation is the emission of fumes from the tanks during the plating process. Fortunately, we do not have to deal with this in the same way as the commercial platers, due to our 'miniature' systems.

In the case of nickel, copper, Copy Cad, Copy Chrome and zinc plating, the fumes are hardly noticeable, and do not pose any major health risk. However, the chrome, SP Degreaser, anodizing and de-plating tanks do give off unpleasant, and potentially dangerous fumes. These need to be considered and controlled.

We suggest you manufacture a small fume hood and/or install a fan system to move the fumes away from yourself. An ideal ready made inexpensive hood is a kitchen stove fume hood. The use of a respirator is also advisable.

Our Chrome kits have a fume control system. This comprises of a bag of plastic balls and an EPA compliant mist suppressant which is mixed into the Chrome Activator.

The plastic balls are placed in the chrome tank, and they float on the surface of the chrome. The Chrome Activator is also added to the tank. The mist suppressant in the Activator is a commercial 'oil' which fills the gap between the balls. The combination of these two items, virtually eliminates all fumes from the tank. The balls also hold the heat in. Additional balls may be purchased for use in the pickling tanks.

The actual chemicals themselves are all toxic! None of our systems contain cyanides. All products have a special set of safety and material safety data sheets. Most of the other chemicals are either acids or alkalis, either type will burn skin and blind eyes if the proper precautions are not taken.

**You should use goggles, gloves and an apron while using your plating operation.**

### **Acid Spills**

Keep a box of Sodium Bicarbonate (Baking Soda) handy. Sprinkle on the spill to neutralize the acid. Then mop and flush.

**Disposal of chemicals** (for more details see- Waste Disposal & Emmissions)

Most plating chemicals contain heavy metals. They should not be flushed down drains, even in small quantities.

To dispose of chromic acid solution, you may purchase a small Chrome Neutralizer kit from us. Simply add all the contents of the kit to your chromic acid and allow it to work. Then you may pour the solution down the drain. The sludge at the bottom of the tank should be placed into a plastic container and handed in at any 'transfer station' where you would dispose of household paint. Do not 'flush' this sludge. It is a heavy metal.

When you finally dispose of the other chemicals, you should evaporate off as much water as possible, place the remaining sludge in a plastic container, and take it to a 'transfer station', telling them what the chemical is. They will usually dispose of it for you at no charge, considering the small quantity, preferring to do this than let them be flushed!

In the case of spent SP Degreaser this is only a caustic solution and is drain safe, so can be flushed into a sewer system.

Spent acid solutions from the preparation tanks can be used to clean up concrete or neutralized with baking soda. Ask the supplier of these materials for correct disposal procedures.

### **Some DON'Ts**

- Don't pour water into any acid, it can heat up and sometimes explode. Pour acid into water.
- Don't come in contact with Chromic Acid. It will burn, stain and is a dangerous material if not treated with respect.
- Don't think you can get away without taking safety precautions! You can't!
- Don't leave the lids off your tanks when not in use. They WILL get knocked over!

## DIGITAL PH TESTER FOR PLATING SOLUTIONS

The instructions for most of our plating setups now come with the operating pH range stated. Most solutions can be adjusted by either using muriatic or sulfuric acid to lower the pH, or ammonia to increase it. Where you have already used sulfuric acid to make the solution up, such as acid copper, then continue to use the same acid to make your adjustments. Otherwise use muriatic acid. Add very small amounts of adjusting chemicals, no more than a teaspoon full at a time, and wait at least 1 hour, stirring or agitating the solution. Otherwise you run the risk of see-sawing from one extreme to the other. When you first setup your tank, check the pH of the distilled water. It should be 7. Make up the plating solution and then check the pH again. It should fall into the range stated in the instructions.

Accurately measures pH ranging from 0-14 pH.

Pocket-sized, lightweight instrument will quickly test all your plating solutions, and even your swimming pool water.

The unit is splash-proof, and has one point calibration. Full instructions included.



## REVERSE OSMOSIS KIT

This economical Reverse Osmosis unit is compact in size, and has the benefit of being portable. It produces 10 gallons per day. On average, this unit will remove 94-98% of tap water contaminants.

It includes a 10 gallon per day TFC membrane, an IFCE inline carbon/sediment pre filter, a 3/4 inch garden hose adapter and 6 feet of yellow, blue and orange tubing.

This unit can be run on ANY water system, well or city.

We recommend adding a FLUSHKIT to your system to extend your membrane life, particularly in hard water conditions.

The FLUSH KIT enables the membrane to be flushed with pressurized water to help remove contaminate buildup and extend membrane life. This kit comes complete with all necessary fittings to hook up to the RO system.



TFC Membranes will need to be replaced every 3-5 years.

## SOME THINGS YOU MIGHT NEED

You will need to collect some articles before you can start plating. We suggest you read the entire book before trying to collect these items, to determine your requirements for each procedure.

For general requirements -

- A candy or aquarium thermometer
- Distilled Water (not mineral water) , or Reverse Osmosis Water
- Rubber gloves (kitchen type, not latex)
- Goggles
- Plastic Apron
- Alligator clips
- Red & black Plastic Coated copper wire.
- Stirring sticks, preferably plastic or wood, NOT metal!
- Muriatic Acid (or hydrochloric Acid -this is swimming pool or concrete cleaner) 1 gal
- Digital PH meter (available from Caswell Inc)
- Sulfuric Acid (battery acid 1.26 baum) approx. 1 gal NAPA stores - Product # 9002
- Acetone or lacquer thinner 1 gal (for oil & grease removal)
- Bare copper wire, approx. 18g. Heavier gage for Chrome plating.
- Some spare plastic containers.
- 14" lengths of 1/2" copper pipe - to make TANK BARS. One for each tank
- 5" lengths of 1/2" diam copper pipe – for plating practice.
- A respirator with ACID GAS cartridges
- 1 box of Baking Soda, for neutralizing acid spills.
- Magnifying glass, for inspecting your work.



## SETTING UP A WORKSHOP

Although we have shown a complete workshop here, it is NOT necessary to go to these lengths, you can plate from one tank at a time quite easily!



Here is an example of a neat setup, where the entire operation has been enclosed in a home made cabinet. The top has an exhaust system build in, and there are even glass doors to enclose the operation. Note how the tanks are sunk into the worksurface.

Top left hand shows a power supply, which is connected to the bus bars running along the back of the unit. Operating notes/reminders are pinned on the back wall.

Tank heaters are located on the left and right sides when not in use.



### WARNING!

All components MUST be plugged into a CFCI receptical (see [www.marinedepot.com](http://www.marinedepot.com) for yellow portable unit)

As you will be using acids, alkalis, water etc. and doing surface preparation to various metals with grinding and polishing tools, you will be making some mess and a few smells. We recommend you find a place where you can set up that has a good concrete floor, preferably painted with an epoxy (See Caswell Garage Floor Coatings), has some cross ventilation and running water. The kitchen is NOT a good idea!

Plenty of workbench area is a must. You might have up to 4 plating tanks set up at any one time, and will need more space to lay objects out etc.

Set your workbench next to a sink if possible, and tilt the bench so it drains into the sink. Minor spills can be flushed away easily. Some of our customers have purchased 'second quality, slightly damaged' kitchen work tops as benches. They have even cut holes in them to recess the tanks.

Find a free area for your buffing equipment. This needs to be away from the plating tanks, as the dust and small metals particles dispelled into the air, can settle in the tanks and spoil your solutions. Your buffing machine can be mounted on the edge of a bench with one wheel hanging over the side. This allows the part, if caught, to drop fairly harmlessly we hope, to the floor. Alternatively, you could construct a pole stand and mount the motor on that.

You will need some good lighting for the workshop, as you will need to inspect your work thoroughly. The area should be heated to about 68-72 deg. F.

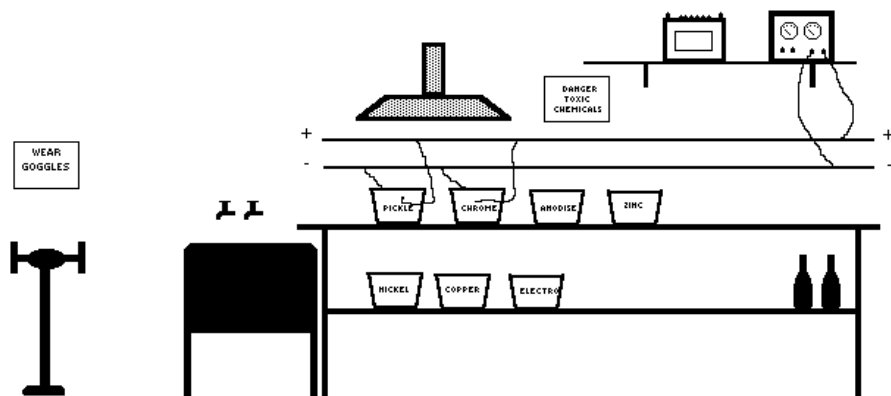

## Setting Up A Workbench

Depending on the size of your kit, you need to make a suitable workbench. Ideally, it will be close to a sink and water supply, and the surface could even be tilted to drain into a receptacle.

A framework of 2" x 4" timbers, is ideal for most triple chrome plating operations. Up to five gallon setups could be set at your waist height, but larger tanks would need to be lower to make it easier to lift the heavier parts in and out of the tanks.

Customers may install a plywood or Formica type surface. Do not use particle board or MDF as the liquids will disintegrate it very rapidly.

Bus Bars are attached to the pegboard by drilling and bolting. Note:- two bus bars running across pegboard.

The actual work surface should be strong enough to withstand weights of 200 lbs or more, (16 gallon kits contain about 150 lbs per tank, so build a STRONG framework and place these tanks on top of the work surface). Do not cut the holes too close to the edges of the board. The plating tanks should fit snugly into the cut hole, resting on the lip around the edge. Ensure the fit is fairly tight.

Additional tanks may be stored on the lower shelf

## Storing the chemicals when not in use

None of our chemicals are damaged by freezing, however if the tanks freeze they may crack open, and give you a real mess to clear up when they thaw. So we suggest you store them in a heated area. Ensure the lids are secure on each tank and mark the tank with an indelible marker, denoting the contents.

If you intend storing the chromic acid from the chrome plating tank, for a long period, say 2 years or more, we suggest you transfer the product to a glass container. This acid will very slowly attack the plastic tank, and may cause you an unpleasant clean up job.

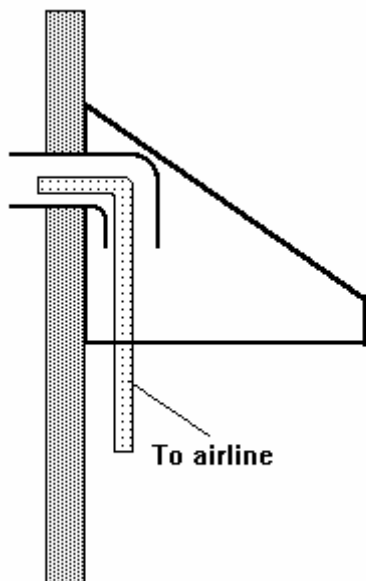

## Making a fume hood

For the occasional plater, a fume hood may be an extravagance, and the problems of occasional fumes can be dealt with by simply opening a window and placing a fan by the offending tank, or simply wearing a respirator with acid gas cartridges.

There are a number of options for a fume hood. Normally, hoods will not be necessary for nickel and copper plating, as the fumes generated are very minimal from these processes, but from the De-greasing, De-plating and Chrome plating tanks some sort of control is almost vital.

A simple hood can be made from plywood, and coated with a bituminous or epoxy paint. Or the use of a range hood from a cooking stove could be a 'ready made' solution. The fan motors in these will usually not last too long, as acid fumes may attack the windings. The best arrangement is to rig up a simple ventura blower, using an air line or a vacuum cleaner exhaust, as pictured above.

Set the hood about 1 foot above the tanks. You can usually get two of our tanks under a range hood. We don't envisage you having many more than 2 tanks running at any one time, so there is no need to make a huge contraption.

Make a hole through to an outside wall, or place your exhaust pipe through a window.

Using some 4" plastic pipe make up an arrangement as shown in the diagram.

Make a hole in the bend of the pipe large enough for you to insert your air line or vacuum exhaust pipe.

When the air line/vacuum is switched on the force caused by the ventura principal will suck all the fumes out through the larger pipe. There are no moving parts and the system is therefore fairly foolproof!

Also see the section on Zero Emissions

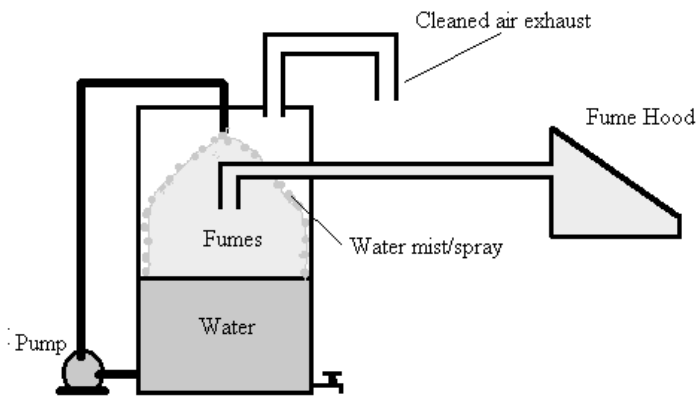

You may also consider constructing a simple 'scrubber unit' to clean the air from your fume hood. Depending on the size of your operation, you can make this set up from something as small as a 5 gal pail to a 55 gal plastic drum

You will need a small water pump, preferably with an all plastic housing and impeller. The pump is there to circulate water around the tank. As the water is introduced back into the tank it must be made to spray out in all directions as a fine mist. It is this curtain of mist that traps airborne particles of acid, 'scrubbing' the air clean as it passes through the curtain.

The acid is contained in the body of water at the bottom of the tank. Very occasionally, you will need to remove this water, evaporate it down by placing our heaters in it, and saving the sludge or concentrate in a small plastic container. You may then dispose of this at your local transfer station. Even a busy shop may not have to do this more than once every year or so. Remember to top up the water level periodically, as it will evaporate off fairly quickly. Adding a couple of boxes of Baking Soda to the water will neutralize the acid as it enters the system.



**Bus Bars**

You may wish to mount two lengths of 1/2" copper pipe along the back wall of the bench. Space them about 6" apart, and mount them on wooden blocks using the 'u' shaped straps designed for plumbing. These are your 'BUS BARS' and carry the power from your battery to the various tanks. They allow you to connect to a power unit saving a 'spaghetti' mess of wires. Remember to get alligator clips large enough to clip onto the copper pipes.

Paint both ends of the top bar RED, and the bottom bar BLACK. You may like to nickel plate these bars to stop corrosion forming on them. This could be your first plating job.

*Note. In the picture left, the bottom two bars are the bus bars*

**The Filter-Agitator Pump**

During the plating operation a small quantity of hydrogen gas is formed on the work piece. If this is not removed, the plate forms around the bubbles leaving tiny craters. It is also important to provide a constant supply of fresh solution over the surface of the part being plated. Vigorous agitation will always improve any plating process. It is important to note that these units **MUST** be removed from the tank and rinsed after each session, otherwise crystals will form within the pump housing, rendering it useless when switched on.

The pump can be dis-assembled for cleaning. The filter should be periodically rinsed out to remove contaminants. This filter may be replaced with a charcoal bag when the need to remove any organic contaminants, such as oil etc. The charcoal filter will remove all brighteners, so use with caution and replace brighteners to those baths that use them.

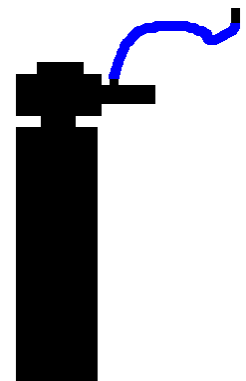

There is a small capped nipple on top of the outlet pipe. Under normal usage, remove the nipple and attach the tubing with the black bobble on it. By attaching the bobble to the tank side above the liquid level, air will be sucked into the outlet pipe, causing vigorous agitation. By immersing the bobble, or replacing the original cap, a liquid only jet will be produced. Most plating solutions (except tin) plate better with vigorous agitation, and will yield a better, brighter and shinier

Filter-Agitator Pumps are not normally required in the CHROME tanks, however, if you are hard chroming parts where awkward shadow areas exist, a constant supply of fresh plating solution may improve the plate.

### **Anodes and Cathodes**

Supplied in each kit is a set of metal plates which can be either a cathode or an anode. The plates are called anodes when they are used in a plating tank, and cathodes when they are used in a de-plating or anodizing tank. Anodes are always connected to the (+) positive side of a power unit, and cathodes to the (-) negative side.

The anodes we supply are of very pure quality. Substituting, particularly copper, is tempting but can result in low quality copper being introduced into the bath, which can cause contamination of the solution and disbonding of subsequent layers of plate.

### **Nickel Anodes 6" x 8"**

Nickel anodes are supplied either singly, or in a set of 2, each with a special bandage. The bandages should be wrapped around the anode, to make an envelope and secured with a rubber band. This prevents the oxide that forms during plating from falling into the solution and contaminating it. The other types of anodes do not usually require this treatment. Note how the bottom of the bandage is folded up and then secured. Always remove the anodes from the tank after plating. Rinse and dry them to store.

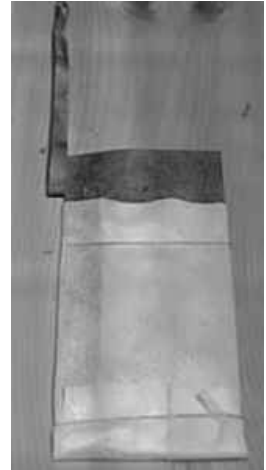

### **Copper Anodes 4" x 8" (High Phosphorous)**

Supplied singly, or in a set of 2, with anode bandage. As of January 1997, we have changed our policy on anode bandages for copper, and they will be added to each pack of anodes. Install the bandages in the same manner previously described for nickel plating. Anode bandages in copper provide a smoother, higher quality plate. Always remove these anodes from the tank after plating. They will deteriorate rapidly if left in the tank.

Pictured right, the anode and bandage, with a strip cut to make the tank hanger.

### **Chrome Anodes 12" x 12"**

These larger plates are used as anodes for chrome plating. The chrome is derived from the solution and not from the anode, so these plates are a permanent fixture. They are a specially made alloy of lead and antimony.

Chromic acid will attack the anode, forming a yellow layer of lead chromate. This acts as an insulator and prevents the anode from functioning properly. Anodes must be removed from the tank, immediately after plating and cleaned with a Scotchbrite pad in fresh water to remove this film. Dry and store the anode ready for the next usage.

Chrome anodes need to be affixed to a heavier wire than all other types of anode, due to the much larger current requirement of the plating operation. To affix the anode to a thicker wire (such as jumper cables), bare approx. 2" section of the wire and roll a corner of the anode around it. Hammer flat to secure. The anode can be hung into the tank, using the wire as its positioning support. Alternatively, use jumper cable clips to secure the anode to the tank wall and make the connection.

**PEROXIDING CHROME ANODES.** As an option for chrome anodes, you may wish to treat them to prevent the build-up of 'lead chromate' This yellow coating prevents the correct function of the anode. It usually occurs if the anodes are left in the solution for long periods without regular cleaning.

Make up a solution of 15% sulfuric acid (battery acid) and 85% distilled water.

Clean the anodes with wire wool, and connect anodes to a dc power supply, one to the negative and one to the positive. Adjust the current to obtain approx 5amps per sq foot of anode surface area. Maintain current for 15 minutes.

Reverse the polarity and repeat the process for 15 minutes.

Finally, reverse the polarity once more, and repeat the process for 15 minutes.

A dark brown coating will form on the anodes, indicating the presence of lead peroxide. This layer will prevent the formation of the lead chromate whilst still allowing the current to flow.

### **Installing the anode/cathodes**

It is imperative that you do not allow any connecting wires/clips etc. to be immersed into the plating solution. Any such foreign objects will be dissolved by the plating action, and the result will be a contaminated electrolyte.

To ensure that ONLY THE ANODE is dissolved, cut a strip down one side of the anode, about 1/4' in. Do not completely sever the strip from the anode, stop cutting about 1/4" from the end. This strip can now be bent 180 degrees to make the hanger and contact for the anode.

Drop the anode into the solution, and bend the top of the strip over the lip of the tank. You may now use an alligator clip to attach your power line to the anode. Attach a second wire from this anode to any other anodes.

### Anode Positioning

Most items can be plated in our round tanks with an anode either side. In larger round tanks several anodes may have to be placed around the circumference. The effectiveness of an anode placement is something you will learn by experience, but as a general rule, try to keep the anode at least 3" away from the article being plated and no more than 9" away. When chrome plating, remember that chrome has poor throwing power, so anodes should be evenly placed around the object.

For long objects, several anodes may have to be placed along the length of the tank.

Objects with recesses may not plate effectively in the recessed corners. To overcome this, you may need to place the anode closer to the recess and actually form it to conform to the recess.



To reach difficult areas, you may need to make a cut in an anode edge and bend a strip upwards, so that it can be pointed into the recessed area. This technique is especially useful for plating inside tubes. See the section on **HARD CHROME PLATING**, for specific anode design.

In the picture, left, a long object is required to be plated on one side only. Both anodes have been placed on one side, facing the part. Their strips are joined together ready for the positive terminal from the power supply to be attached.

If both sides were to be plated, anodes would be placed on either side of the part, which would be centralized in the tank.

*Left. The two tanks bars have the part suspended on copper wire. If the part were to be plated on both sides, additional anodes should be placed opposite the existing ones.*

Anodes give out 'Lines of Force' similar to a magnetic field. These lines travel in almost straight lines from the anode to the part, but, like magnetic force fields they will bend slightly. So an object being plated which is facing only ONE anode, will generally only the side facing the anode plated. Because the 'Lines of Force' bend, some of the back edge of the part may also get plated. This phenomenon will vary from part to part, also depending which type of plating you are doing. Generally, zinc plating will almost plate all the back side of a part, whilst chrome will not, as it has poor 'throwing power'.

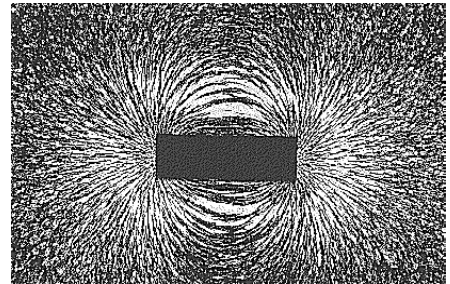

Here are several configurations of anode placement. Tank C shows the anodes hung centrally in the tank, and bent around to keep their surface equidistant from the part. This is especially useful when chrome plating a small part. If the anodes were left in the A tank position, the distance from the part would be so great that the 'chrome anode would be unable to 'throw' the power across to the part, resulting in a patchy, on existant plate. The anodes in tank C could also be made into a complete tube, with the part hung in the center.

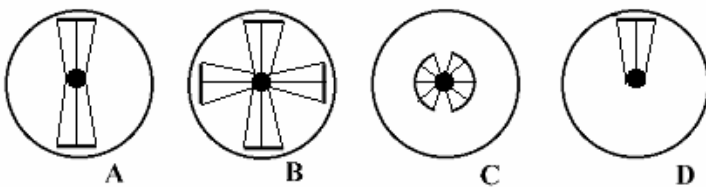
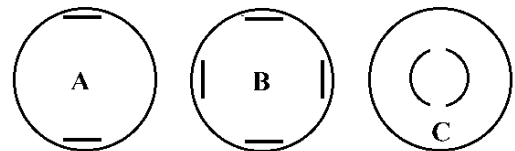

The configuration in tank B could be used when the part has many 'nooks and crannies', ensuring the 'Lines of Force' come from many directions.

Here left, the lines of force are shown. Note in A that the areas directly opposite the anodes get more lines of force, so get plated heavier. Whereas the 'sides' of the part get much less.

In tank D, note that the lines of force are only attracted to one side of the object, so the side 'in shadow' from the anode doesn't get plated.

**GP Plates** 8" x 8" ( General Purpose Plates) Used for Anodizing, Stripping.

In these instances the plates are called cathodes, and are wired to the negative side of the power unit. They may be attached to wire in exactly the same way as the chrome anodes. If the tank is to be stored for any length of time, it is advisable to remove the anodes/cathodes, wash & dry them and store them separately.

**Making up the tanks**

There are two basic types of tanks;

**A. PLATING**

**B. DE-PLATING.**

**A. PLATING TANKS** are used for applying the various metals to the objects. One type of tank will only plate one type of metal, therefore you will have several tanks for triple chrome plating, where the requirement is to copper, nickel then chrome plate. The metal plates used in these tanks to supply the plating metal are wired to the positive side of the power source and are, in this instance, called the **ANODES**. The part to be plated is wired to the negative side of the battery and is called the **CATHODE**. The negative **CATHODE** attracts metal from the positive **ANODE**. The negative **CATHODE** attracts metal from the positive **ANODE**.

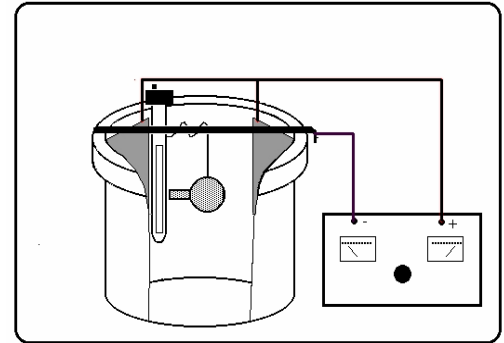

**B. DE-PLATING TANKS** are used for:-

1. removing old plate
2. anodizing aluminum
3. dissolving rust
4. electric etching

These tanks are set up in exactly the same way as the plating tanks, except that they are wired up **IN REVERSE**. So you end up - **DE-PLATING**.

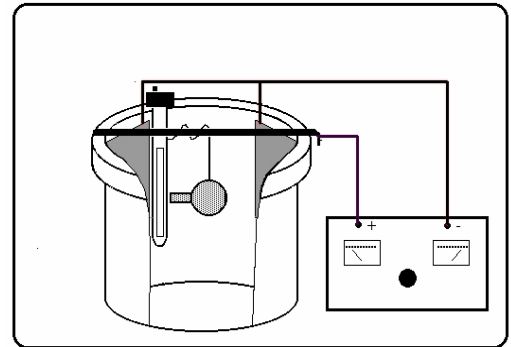

Our previous policy was to bolt the anodes/cathodes to the side of the tank, but now we prefer to cut a strip along the long side of the anode and use this as the hanger. This enables the anode to be placed deeper into the solution, with no fear of contamination from the hanger.

**Plating long objects.**

As our tanks are cylindrical in shape, this can cause some problems when plating longer objects. Most objects can be half plated, then turned in the tank and the other half plated. Where there is a join mark, this can be buffed out leaving no signs of its existence.

Pictured right is a plastic window box. Note how the anodes are placed on one side only. In this instance, only one side of the object needs plating. More anodes would be needed to plate both sides, or the object could be turned and the process started over for the other side.



## THE WORONKO PLATING CHAMBER

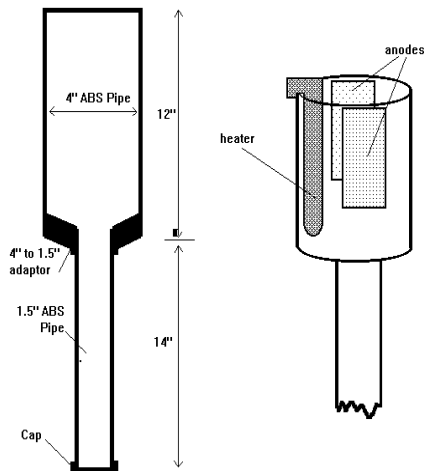

This ingenious tank was developed by Mr. Henry Woronko, a customer of ours.

The set up is extremely simple and inexpensive to make, and can plate parts up to 6 feet long, if adapted.

Once the tank is assembled, it should be wrapped in fiberglass, or pipe insulation and covered with plastic sheet to protect it from the splashing chemicals.

Seal it with duct tape. This will keep the temperature constant which is a major consideration when chrome plating.

Increase the solution's recommended temperature by 20 deg. F when using this set up, as the larger and cooler part will drop the temperature as it is introduced to the system. This particularly applies to chrome plate.

All our procedures can be used in the tank, de-plating, anodizing, and all other plates. Ensure you rinse the tank thoroughly between changes! If you chrome plate, make a special tank, specifically for the purpose, and do not use it for any other type of plating, otherwise you will contaminate your solution.

The Woronko Plating Chamber is operated by hanging the long thin part into the fatter area of the chamber, and held there until that section of the piece is plated. As soon as there is sufficient plate, the piece is lowered, so the plated area now drops into the lower, thinner section of the tank. The process is repeated until the entire item is plated. There will be no 'tide marks' or bumps in the plate using this technique. Extra long items could be plated down one half, then turned around and plated from the other end.

### MAKING A TANK BAR

Using a hammer, flatten about 1.5" of each end of a 1/2" x 14" copper pipe. On our 1 to 5 gal plating kits, use a 1/4" diameter pipe. On the 15+ gal kits, use a 1" pipe. Bend the ends at 90 degrees, so that they fit over the outside edge of the tank. These bars will be used to suspend parts in the tank.

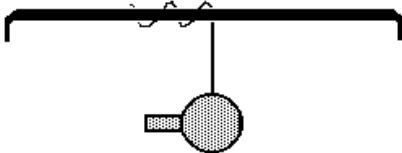

For most applications, simply wrapping the wire from the part around this tank bar several times is sufficient. However, to ensure good electrical contact, you may wish to drill several holes along the length of the pipe and insert some brass bolts & secure with nuts. The part's wire can then be affixed to these bolts and locked into place with another nut.

Keep the bar clean by occasionally scrubbing with wire wool. This ensures a good electrical contact. You may plate the bar with a nickel plate to reduce corrosion. Use these tank bars as your first plating job!

If you are going to hang really heavy articles in a larger tank, cut a steel reinforcing bar, and coat it with epoxy paint, then insert it inside your copper pipe. This will dramatically increase the tank bars holding capacity.

## HEATING THE SOLUTIONS

Our new tank heater system is designed to be simple and reliable. It consists of an external thermostat unit, and a 300W Quartz heater that can be fully submersed in any tank. The thermostat unit has a range of 110 deg F – 140 deg F. You should use this system whenever the plating manual calls for temperatures in this range.



**Image 1 - Thermostat Unit With Heater Attached**



**Image 2 - Heater Installed In Bucket With Temp. Sensor**

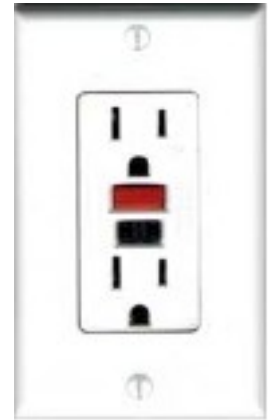

**WARNING! All heaters & thermostats must be plugged into a CFCI receptical.**

### How To Use:

1. Install heaters in tanks so that they are fully immersed in the solution. One heater per tank will be sufficient to bring 4.5-5 gals to 140 deg F.
2. Attach the temperature sensor inside one of the tanks, as far away from the heater as possible, so that it is fully immersed in solution. This one sensor will control all the heaters attached to the unit, so it's best to have separate thermostat units for tanks with different operating temperatures.
3. Connect up to 3 x 300W heaters into the plug on the thermostat unit.
4. Turn the dial on the thermostat unit so that it points to the desired temperature.
5. Plug the thermostat unit electrical cord into a regular 110V household outlet.

### Tips & Tricks:

1. Do not use this unit to control degreaser, electroless nickel/Krome or anodizing sealer tanks. Simply plug the 300W Quartz heater into an electrical outlet and unplug when the desired temperature is achieved.
2. Do not run the heaters when the solution level is below any part of the heater. Doing so will cause the heaters to break.
3. Do make sure to install the temperature sensor as far away from the heater as possible. This will ensure accurate temperature readings.
4. Check your baths with a thermometer to ensure accuracy.
5. Triple chrome plating kits have two thermostat units, because you need to control 4 heaters total.

### Insulating the plating tanks.

Simply by taping an insulating material around the side and the bottom of your plating tanks, you can rapidly decrease the amount of time required to warm up the solution from cold, and particularly in the case of chrome plating, attain a higher temperature using only aquarium heaters.

There are several suitable materials for this. Many hardware stores sell an aluminum foil combined with a bubble wrap especially for insulating domestic water heaters. It comes in various widths and is very inexpensive.

There are several sizes of 'Bubble Wrap' packaging material available at many





'office supply stores'. Even a layer of corrugated cardboard covered with plastic sheet (to keep it dry) will make a huge difference.

The inclusion of mist control balls to any plating tank, will also hold in the heat. We only ship these with chrome and anodizing kits, so they may need to be ordered separately. In the picture here, a mist suppressant is also being added.

### Heating larger kits

Larger tanks, such as the 16 gal kit, may be heated with commercial quality heaters such as the ones shown here. The section containing the heater may be made of quartz, titanium or stainless steel, depending on which chemical it is heating. These heaters come with a thermostat control and a probe which is inserted into the solution. They operate on 110 volts.

A typical 16 gal Triple Chrome Plating kit contains:

- 2 x 1000 watt Titanium Heaters  
(Copper & Nickel)
- 1 x 1000 watt Quartz Heater with guard  
(Chrome)
- 1 x 1000 watt Stainless Heater
- Degreaser
- 4 Control Boxes



## WIRING UP THE PARTS

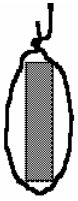

Brass wire is probably the best to use, but is more difficult to obtain. It does not oxidize as quickly as copper or steel. We have always used copper wire with no adverse effects, 10-20 gauge wire is ideal. For chrome plating use a fairly heavy gauge, and/or double it up, as this procedure uses high amperage, which may melt a thinner wire.

Do NOT use steel wire - or copper coated steel wire - it will NOT conduct properly!



When ANODISING, only use ALUMINUM wire from the tank bar to the part. The wire needs to be SECURELY fixed to the part, otherwise it produces an insulating coat of anodize and then no longer conducts, so the part will not receive any more power, and the process ceases. For those anodising on a continuing basis, a Sputwelder is an excellent investment. This device actually welds the aluminum wire to the part.

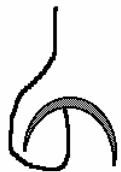

Each part needs to be carefully examined to find a suitable place where a wire can be attached, so that it may be hung from the tank bar. There is a good possibility that every place a wire touches the part, the plating process will leave a mark. So, if there is an underside it will always be better to fix to this. Wire the part so that only the edges are touched, bending the wire away from flat surfaces. Alternatively, parts can be suspended from hooks made from wire, so only the point of the hook is touching the part. (See diagram).

Running wires through an existing hole will often eliminate wire marks.

Another technique is to frequently move the wire to another location; i.e., spin the part, so that the touch point is lessened to any particular point. Occasionally it will be inevitable that you leave an odd wire mark. This can usually be buffed out with a little care.

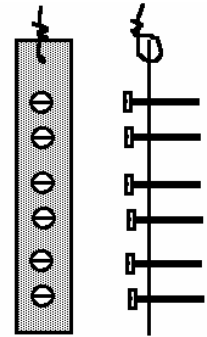
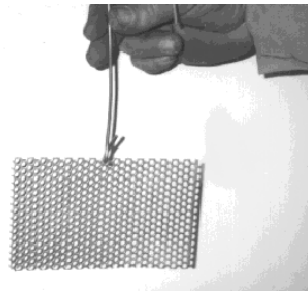

Some small parts can be strung on a wire with plastic beads separating them, and then plated all at the same time. Other small parts such as screws or bolts can be fixed into holes drilled into a thin sheet of brass, copper or steel and plated as one, or fixed on to a piece of expanded metal, see below).

If only the heads of bolts require plating, screw them into a metal sheet and immerse just the heads in the liquid. Alternatively, you could wrap a wire around the thread and then suspend each bolt from the tank bar into the solution, so that just the head is immersed.

A small plastic basket, such as those found in dishwasher to hold flatware, makes an ideal receptacle for plating some small parts. Weave bare copper wire in and out of the latticework in every direction, along the bottom and sides of the basket. Fix one wire to come up the handle so that it can make a connection with the tank bar. Small parts can be thrown into this basket, knowing that they will make contact with the wire and therefore become conductive. The basket can occasionally be shaken so that the plate is applied evenly.

For some hollow objects, where the inside will not get plated, you can use a spring clip (figured right) to hold and connect the part whilst it is being plated.

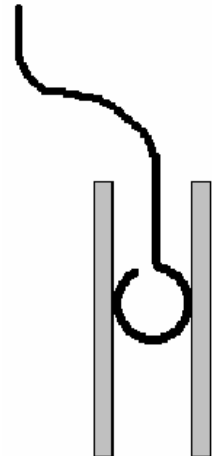

When chrome plating, you will need to make these wires from very thick single strand wire, and may even need to run several wires to the one object to ensure enough current is conducted. With these stiffer single strand wires, you can make hooks that will hang from the tank bar. By stripping the insulation from only the ends, you can make hooks that do not get clogged up with plating, and may be used over.

**All fastenings to the parts need to be secure, especially when dealing with higher currents and in processes such as Chrome plating and Anodizing.**

## **SPUTWELDER**

The Sputwelder is an optional product, ideally suited to those running a small plating or anodizing business using our kits. It eliminates 'connection' failures in plating and anodizing. The device welds the hanging wire to the part instantly, making over 100 connections an hour possible, much faster than racking. Works with aluminum, steel, stainless steel, copper, brass, or titanium

It leaves a smaller scar than conventional connectors on anodize. The unit is very safe with no chance of shock.



Most people who are anodizing have experienced the frustration of preparing a piece and going through the entire anodizing process, only to find the connection was weak and the anodize layer is poor. Due to the infinite variety of shapes and sizes, making an unobtrusive anodize connection can be very difficult to do conventionally. Usually, the connection quality is sacrificed in favor of aesthetics.

With anodizing in particular, a weak connection to the work piece will allow an anodize film to grow between the work and the anode wire, effectively insulating the work piece and reducing the current it requires. By using the Sputwelder, the end of the wire is instantly fusion welded to the part, making the connection immune to anodizing. The instant the arc weld is made, the unit is completely and safely discharged.

At the end of the process when the wire is removed, the weld scar is only slightly larger than the diameter of the wire. No weld scar or even a heat blemish on the opposite side of the work.

## **Estimating Plate Thickness**

The section of wire that is immersed into the solution can be used as a good indicator of the thickness of the applied plate. Simply measure the wire thickness before plating commences and again afterwards, using a micrometer.

## **Hydrogen and Air Entrapment**

You should give some consideration to the problem of trapped bubbles when hanging the parts in the tank. Hydrogen bubbles form during all plating processes and if they are allowed to collect, they form a gas pocket which displaces the solution and stops the exposed area from plating. Air can also be trapped during immersion. Always make sure the parts are hung to avoid this.

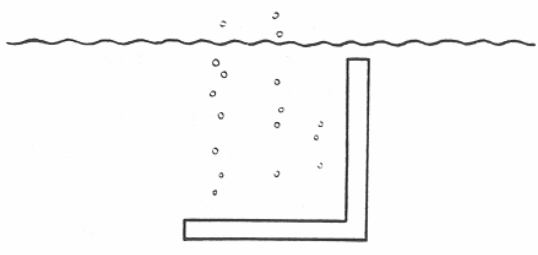
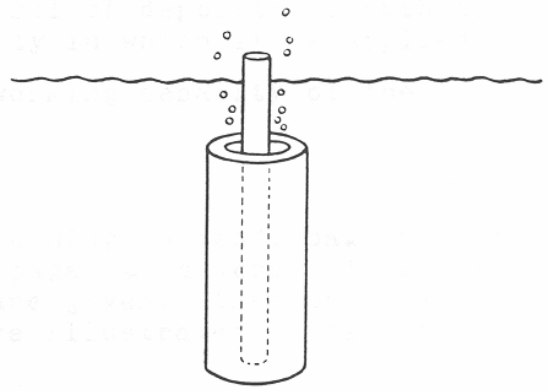
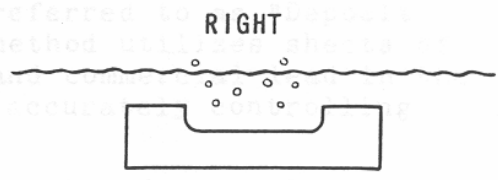
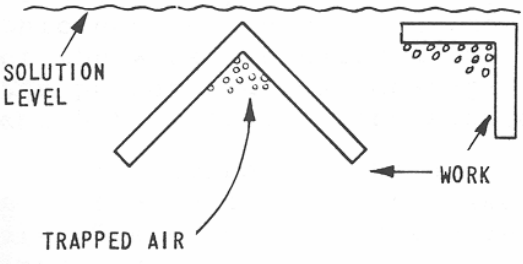
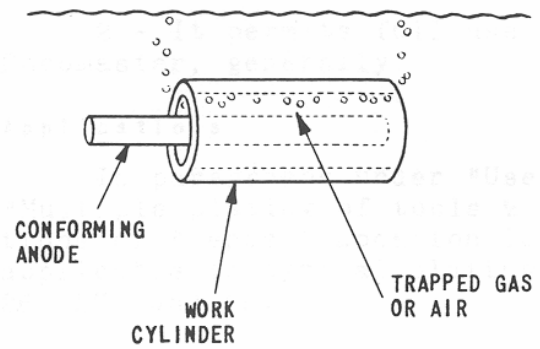
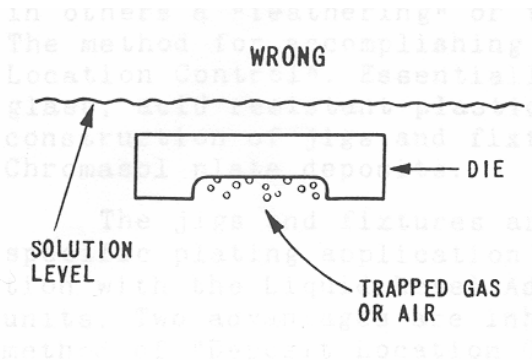

## Power Supply Basics

### READ THIS FIRST

Power supplies come in all sizes and types. This will help you determine which are suitable for electroplating and anodizing and which are not.

#### Power Supplies or Rectifiers

The term rectifier was used to describe power supplies in the 19th Century. 'Electronics' had not been invented so power supplies as we know them didn't exist. In spite of not being used for 100 years the name 'rectifier' stuck, and power supplies used for plating and anodizing purposes are called this in the Industry.

#### Regulated and Non-Regulated Power Supplies

A regulated power supply has a circuit to hold its output to a particular value when the load on the power supply changes. A non-regulated power supply does not have this circuit, so its output will change as the load changes. A common example of regulated would be the power supply in your personal computer. An automotive battery charger would be an example of a power supply with no regulation.

#### Adjustable and Non-Adjustable Power Supplies

An adjustable power supply has a control to allow the user to adjust its output, and a non-adjustable power supply does not. Your computer power supply is non-adjustable and so is your battery charger. All plating and anodizing rectifiers are adjustable, as are laboratory type electronics power supplies. For all plating and anodizing purposes, an adjustable power supply is required.

#### Power Supply Regulation, CV and CC Methods

There are two regulation methods in common use, Constant Voltage (CV) and Constant Current (CC). Constant Voltage (CV) regulation has the means to measure its own output voltage, and a circuit that compares this to a reference voltage set by the user (the Volts knob). Regulation is achieved by the power supply constantly adjusting its output voltage so that it matches the user set reference. Hence the name, Constant Voltage. This will operate up to the maximum current capability of the power supply, called its current limit.

Constant Current (CC) regulation has the means to measure its output current, and a circuit to compare this current to a reference current set by the user (the Amps knob). Regulation is also achieved by the power supply constantly adjusting its output voltage, but this time so that the output current matches the user set reference current. Hence the name Constant Current. This regulation is maintained up to the maximum voltage the power supply is capable of, this limit is called the power supply's maximum voltage compliance.

Laboratory type power supplies often have both types of regulation and can operate in either CV or CC modes. The Caswell 3 Amp and 20 Amp CV/CC rectifiers are examples of these.



3 amp



20 amp

#### Power Supplies for Plating

A CC power supply is clearly the easiest and best type to use for any plating application. Many of the electrical problems encountered by new platers can be avoided entirely by using CC. Not the least of these problems is plating at a consistent current; as the plating process continues, small changes in electrical characteristics of the plating setup occur which cause

significant changes in the plating current. This in turn can cause uneven plating thickness and poor plating adhesion. These changes are unavoidable, and with CC operation the power supply compensates for them automatically, requiring no action or adjustments by the plater. For this reason Caswell Inc. recommends the use of CC for any and all electroplating applications.

### **Power Supplies for Anodizing**

A CC power supply also greatly benefits anodizing. Since the anodize film is an insulator, the changes in electrical characteristics during the process are much larger than in plating. CC operation provides a uniform anodize pore structure all the way down to the base metal. This promotes even and deep dye penetration, and the consistent pore structure provides a better looking and stronger anodize coating than if the pores are distorted by changes in the current. For this reason Caswell Inc. recommends the use of CC for any and all anodizing applications.

### **Battery and Light Bulbs as a power supply.**

For many years we have suggested using light bulbs to control a batteries power supply. This method is very simple and effective, and very inexpensive, however the control is very restricted. The technique was primarily used for the smaller sized plating operation, using less than 3 amps. Our new 3 amp Power Supplies are so inexpensive, we are therefore discontinuing recommending this method. For those still interested in it, please visit the see the FLASH VIDEO on <http://www.caswellplating.com/movies/index.html> concerning controlling the power with light bulbs.

## Sizing a Power Supply for Plating

We have established previously that a CC power supply will provide the easiest and best results. The next question would be how large the power supply should be. This must be carefully considered as the power supply is often the most costly component in a plating setup.

### Power Supply Voltage and Current

Current (amps) does the plating, not voltage.

There needs to be sufficient voltage to support the required current, or that required current cannot be obtained. All common forms of plating involve plating metals onto the work; and most metals are good conductors of electricity, so the voltage requirements are low at about 3 volts or so. Better conductors (copper, gold and silver) require less voltage and poorer conductors (like chrome) requiring more. In all cases, the bulk of the 3 volts is dropped by the electrolyte itself. This is because the electrolyte is a solution made with water, which conducts electricity much less than the metals.

The required current for a given plating job depends on the current density specified for each type of plating, and the surface area of the work to be plated.

Our plating kits can be put into two categories; 'Chrome' and 'Everything Else'. The Everything Else category requires current densities of 9 amps per square foot or less, and Chrome requires about 200 amps per square foot.

### Surface Area

Surface area is a measure of the entire surface of the work to be plated, or in other words, all of the work in contact with the electrolyte. Since it is an area, it is given in square feet (or square inches). It is essential for a good plating job for it to be within 10-20% accuracy.

### Some Power Supply Sizing Examples

#### Example 1

Most platers want the capability to plate more than one metal. Flash plating and undercoat plating are often required on materials such as steel and aluminum. According to the Plating Manual, flash copper requires 9 ASF. If you selected a 3 amp CC/CV power supply, you could plate  $3 \div 9 = 0.33$  square feet with Flash Copper. If instead you selected a 20 amp CC/CV unit, you could plate  $20 \div 9 = 2.22$  square feet with Flash Copper.

#### Example 2

According to the Plating Manual, zinc requires the highest current density (20 ASF) of all others in the Everything Else category. If one chose to forgo chrome plating, a 3 amp CC/CV supply would allow  $3 \div 20 = 0.15$  square feet to be plated with any metal except chrome. 0.15 square feet is  $0.15 \times 144 = 21.6$  square inches, which would be suitable for plating many small objects. If a 20 amp CC/CV unit was used, you could plate  $20 \div 20 = 1$  square foot. That's  $1 \times 144 = 144$  square inches.

In both examples, the voltage required was still about 3 volts. In practice some spare voltage will be needed for the inevitable voltage drop of the wiring. Allowing an additional 3 volts for the wiring is safe in most plating setups. This means that a 6 volt adjustable CC/CV would be all that is required. Unfortunately, low voltage adjustable CC/CV power supplies are not very common. This is because the majority of applications for power supplies of this type are for powering electronics, where higher voltage lower current units are the norm.

### Power Supply Power Ratings

Power supplies are commonly rated in Watts ( $W = \text{volts times amps}$ ). The 20 amp CC/CV supply discussed here is capable of 30 volts, so its power rating is  $30V \times 20A = 600W$ . Since only 3V is used for the actual plating, only  $3V \times 20A = 60W$  is actually used, that only 10% of what the power supply is capable of. When the voltage is increased to allow for the wiring, the power goes to 120W. This is still only 20% of the power supply's capability.

## Making a NICHROME Power Controller

The use of lengths of Nichrome wire is an extremely inexpensive method of controlling larger current requirements used in chrome plating. Nichrome wire is often used in heating elements, such as electric fires.

One 34.5" length of # 18ga Nichrome wire will give a resistance of 1.2 ohms

Using a 12 volt battery, one wire length will limit the current to 10 amps, 2 lengths will provide 20 amps, and so on.

Using combinations of the sets of wires will give a good range of operation. For example: to obtain 90 amps, simply connect the 50, 30 and 10 amp connectors to the buss bar. To make a 5 amp resistor, simply take a length of wire TWICE the normal length of 34.5" (69").

The wire can be ordered from:

**Pelican Wire Company, Inc.**  
**6266 Taylor Rd.**  
**Naples, FL 34109-1839**  
**Sales: (239) 597-8555 Fax: (239) 597-9783**

Or online at [www.pelicanwire.com](http://www.pelicanwire.com)

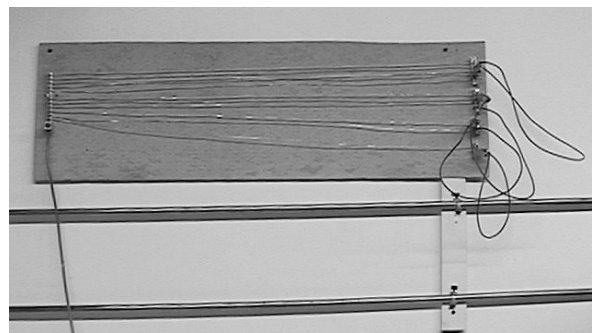
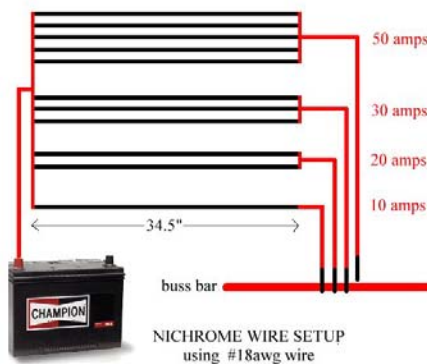

The installed panel, on fireproof cement board.  
Mount the board on blocks, away from the wall.

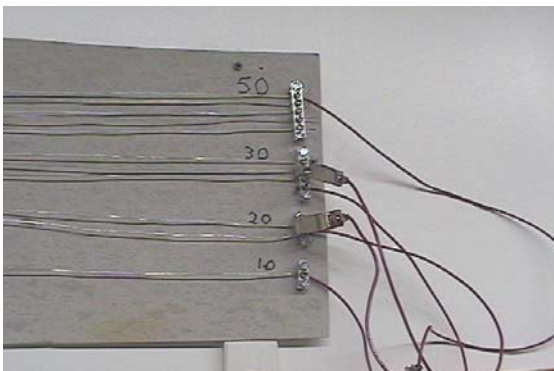

Connectors cut up and bolted to panel

In the diagrams here, we have limited to total number of wires to five, giving 50 amps, but more banks may be added and theoretically, the quantity is limitless. However, bear in mind that these large currents develop extreme heat. These wires will run at around 800 degrees F, so left unattended there may be a fire risk.



## A FINAL WORD ABOUT POWER

A simple way of explaining what we are trying to achieve by controlling power, is to compare our battery and wires as to a water reservoir and pipeline.

The battery (or power supply, such as a rectifier) is our reservoir. The deeper the reservoir, the more pressure we have at the bottom of the reservoir (where we draw off the water) The water pressure is VOLTAGE in our electrical circuit.

Imagine we have a huge pipe, say 4 feet diameter, at the bottom of our reservoir, and we leave it open. It wouldn't take too long to empty that reservoir. In the case of the battery, if we had a very fat wire, such as a jumper cable, it wouldn't take too long to empty the battery if we 'opened' (or grounded) that wire.

Now imagine we have a 1/2" open pipe from our reservoir and we leave just that one open. Its going to take a LONG time for that reservoir to empty. This is a thin wire. Too much pressure from the reservoir can actually burst this pipe, (or melt your thin wire)

In the first example, we need a fair amount of that pressure, but we don't need the volume of water (flow or amps), so we need to place a valve in the line. If the valve is adjustable, we now have a 'rheostat' and we can control exactly how much water we let down the pipe.

Experience tells us that certain types of plating need specific voltages and amperages to plate nicely, so it is extremely important to control these flows of current.

There are two things to consider; is the pipe strong enough, and do we have the right valve (or rheostat) to correctly control the current?

Once this principal is mastered, controlling the power is relatively easy

## REPAIRING PITTED METALS

Our first choice of repair technique is to fill the pits with PITSTOP. This is a 2 part epoxy resin, loaded with pure silver. It can be sanded down, and it will bond to almost any metal. It cannot be used on metals subject to heat over approx 180 °F. For deep holes, these should initially be filled with a less expensive resin such as Bondo, and the Pitstop used as a thin layer overcoat.

### **Steel, Copper, Brass, Bronze, Nickel**

The part must be thoroughly cleaned, preferably by bead blasting and/or electrostripping to remove rust. If the surface has very minor pitting (orange peel texture) then this can usually be filled using a copper plate. Prime steel with nickel or Flash Copper first.

### **The use of copper plate to repair pits**

Apply the Bright Acid copper plate, and then sand down with a fine wet & dry paper using a sanding block. Repeat the process until the pits are completely filled with copper. Then buff and polish and finish with a nickel and/or chrome plate. (see below)

If the pits cannot be filled with copper, use a paste grade solder paint, which can be applied with a brush to the surface prior to heating. This allows a thin layer of solder to be applied making the application of larger quantities of stick solder easier, if required, for filling deeper pits. Steel, copper, brass, and nickel can all be repaired this way.

After any soldering soak the part in hot SP Degreaser to remove any flux.

### **Filling shallow pits & scratches using copper plating**

This technique is ideal for a substrate with many shallow pits of approx. 1/16" depth.

The pitted part should be first plated with a 'strike coat' of Flash Copper (1) for approx. 15 minutes. This layer of nickel is not effected by acid and ensures the part is completely protected from the acidic copper solution.

A heavy layer of copper is applied (2), usually for at least 30 minutes. Periodic checks should be made to ensure the plate is smooth. If not, remove and sand lightly, taking care not to damage the Flash Copper 'strike' coat. If your part is pot metal and you do sand through to the pot metal, you will have to 'strike' coat the part again with Flash Copper. Alternatively, you could 'touch up' this area using the BRUSH PLATING technique. Flash Copper solutions will brush plate, as long as you use a copper wand.

Once a heavy layer is applied, this can be sanded smooth (3). We have found that it is easier to apply the plate in several layers, sanding lightly between layers. This ensures the copper is removed from the high spots, and left in the pits.

A final layer of copper is applied (4), and then buffed lightly to a high polish. Do not get the part too hot during buffing, or you may make the plate blister.

Finally, the part is returned to the nickel plating bath and plated for 15 minutes (5). The part may be chrome plated immediately after this nickel plate.

### **Filling pits using solder**

Apply a 30 minute 'strike' coat of Flash Copper.

Apply a paint coat of Plumb-Loy the area to be repaired, then melt in the solder, by either using a small blowtorch or a heavy duty soldering iron. The area must be heated sufficiently to allow the solder to flow into the hole, yet not hot enough to make the copper plate disbond. Fortunately, Plumb-Loy melts much easier than stick solder, but the could also be used in many situations.

Finally, sand down the solder, ensuring you do not go through the Flash Copper 'strike' coat, and Bright acid copper, then nickel plate directly over. Ensure that you return the part to the degreasing bath to remove flux before the final plate.



## The Repair and Replating of Pot Metal (or Zinc Die Casting)

Pot Metal is probably one of the worst things to repair and replate. The metal varies tremendously in its consistency, the foundry seemingly blending whatever metals (usually zinc and a little aluminum) they had available on the day. This, coupled with the fact that the zinc corrodes quickly when exposed to the elements, can make the product seem almost impossible to repair.

Pot metal has always been a major problem for the average restorer to repair, as it can't be welded, brazed or soldered with conventional materials. Commercial platers use a cyanide copper 'strike' coat then plate with acid copper. The cyanide is, of course, a product that many don't wish to handle. So, the only route has been to send pot metal parts out to a professional restorer, usually at great expense.

FLASH COPPER substitutes cyanide copper systems, doing exactly the same thing but without the dangers. Now you can plate directly onto metals such as pot metal, pewter, lead and steel with copper. For more information, see the section on FLASH COPPER.

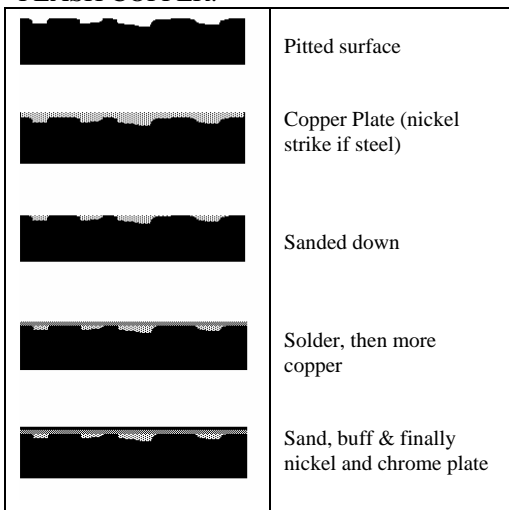

Zinc is a poor choice for a casting. It is readily attacked by acidic situations, as can easily be demonstrated by dropping an eye dropper droplet of battery acid on a cleaned area of a casting. The zinc will start to 'fizz' & bubble' as the zinc is destroyed. Aluminum does not do this, so this is a good way of testing for Pot Metal.

On first examination, an old pot metal part that has been chrome plated will have the characteristic blistering all over it. It would appear that if these blisters were sanded down, the part would be in a good enough condition to replate, but, unfortunately, this is often not the case. These tiny blisters in the chrome plate are just the tip of the iceberg, for when they are examined closely with a magnifying glass, one can see quite deep holes filled with corrosion. This corrosion grows with a tremendous force, pushing the plate from the surface and forming the blisters.

There are many reasons why pot metal corrodes in this way. Poor initial surface preparation. Contaminants in the actual metal. Thin plating being

porous and letting the elements through to attack the zinc. The casting itself seems to be porous, holding in moisture like a sponge.

A characteristic of old pot metal is that the corrosion formed in a hole in one area effects the surrounding, seemingly good, area of the metal, making it difficult to plate.

The best way to deal with these defective areas is to bead blast the surface, then inspect it thoroughly for dark spots in the pits. These dark areas are oxides formed by the corrosion. The must be removed. Either re-blast the part, or get a small drill and gently drill out the corrosion until you find bare, clean metal. On no account proceed to plating until this problem has been resolved.

Now you have a choice of repair options. You can use Pot Metal Solder and make repairs to the bigger holes, or you can plate with FLASH COPPER, then BRIGHT ACID COPPER, then use Plumloy solder, and then overcoat with FLASH COPPER. You will need to make a determination of which method you prefer depending on your own skill levels.

### Preparing the surface

Pot metal has many impurities in it, and the older it gets the worse the part can become. Many castings are porous and absorb water. This can cause many problems during repair, especially during soldering.

### Pre-repair heat treatment

In order that the part be cleansed of these impurities and any possible moisture, it should be placed in an oven and baked as follows:-

15 mins @ 150 deg F      this gradual increase eliminates any warping/stress etc.  
 15 mins @ 300 deg F  
 15 mins @ 450 deg F

At this higher temperature you will find that SOLDER-IT pot metal solder will fuse to the surface easily. A blow torch may be needed to heat the part a little more. Let the heat travel to the solder, do not directly torch the solder as you will burn off the flux and it won't stick properly.

If the repairs are extensive, you may wish to hang the already hot part over a hot plate while you work on it. If you allow it to cool too much, no amount of localized blow torch heat will bring the part up to the correct temperature and you risk damaging the part.

If the part has deep pitting it is usually best to drill out the entire area, ensuring that the corrosion is completely removed. If any is left it will cause a black streak in the plate. This procedure can be likened to drilling and filling a tooth, only less painful! A Dremel tool is ideal for this work. As you are going to completely fill this hole with solder, you can wiggle the drill around a little to undercut the hole, improving the strength of the repair. Sometimes the hole may have to be made right through the part. A piece of tightly crumpled aluminum foil is placed behind the hole when the solder is run in, stopping it from flowing right through. This can be removed after cooling.

Once the part has been successfully repaired, the entire surface needs to be cleaned and polished in the normal way to accept a plate.

Pot Metal has large quantities of zinc in it, which form oxides on the surface of the metal. These have to be removed to allow the FLASH COPPER plate to bond correctly. As this metal does not like the acid in the Electro-strip tank, a procedure which could damage the part if overdone, we should consider these other ways to rid the surface of these contaminants. Abrade with emery paper, Sand blast, Britex or Scotchbrite wheels

Pot Metal should NOT be introduced into the regular Nickel Plating tank, which is acidic and may damage the Pot Metal part.

### **Removing Old Plate From Pot Metal**

The sand blasting technique may be employed to remove CHROME PLATE. Alternatively, a Scotchbrite Pad as a buffing wheel, or a Britex Wheel will do a good job on most parts.

**NO OTHER PLATE WILL STICK TO CHROME- YOU MUST REMOVE IT!  
DO NOT USE ACID TO REMOVE THIS PLATE.**

Underneath the chrome is nickel plate, you will see the yellowish color of the nickel as you remove the chrome. If the surface of this plate is undamaged, it may be left as it will accept a new plate, but you will probably find it is easier to sand blast all the plate off.

Soldering is a skill. You need to practice if you have not done this before.

*This preheated door handle is about to have the SOLDER-IT solder applied. The part will be heated close to the repair, to bring the part up to solder melting temperature. Care is taken to avoid burning off the flux.*



## PREPARING YOUR SOLUTIONS

The following symbols will appear on all product labels where appropriate



CORROSIVE

POISON

TOXIC

FLAMMABLE

REACTIVE

### MAKE SURE YOU UNDERSTAND THESE SYMBOLS BEFORE USING CHEMICALS!

All the plating and de-plating solutions are fairly easy to prepare providing you follow these simple rules.

Always use distilled or de-ionized water. (Not mineral, tap, well or spring water). You may use water from a dehumidifier, air conditioner, clean snow or clean rain water. Better still, purchase a Reverse Osmosis system from Caswell Inc. and produce up to 10 gallons a day from tap or well water.

Read the instructions on the labels on each packet of chemicals.

LABEL INSTRUCTIONS SUPERCEDE MANUAL INSTRUCTIONS SO IF IN DOUBT, ALWAYS FOLLOW THE LABELS. See right for a typical label.

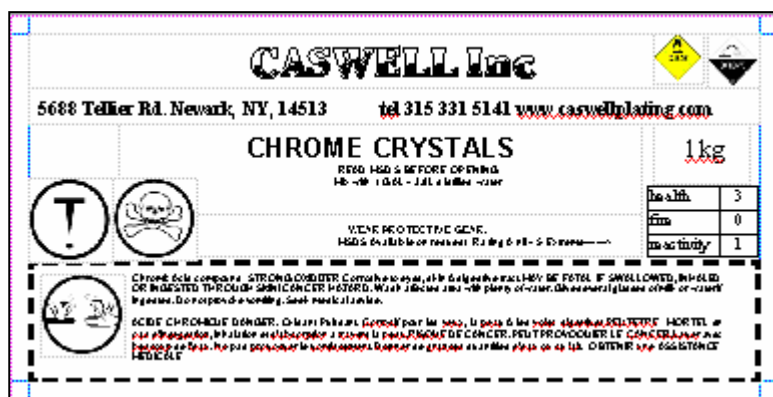

Measure out any additions, such as battery acid in the copper and chrome tanks, before you add them to the tank. It is far better to check them over twice before adding them, than try and rectify the addition of too much acid later. (There is an old carpenter's saying, "Measure twice, cut once!".)

### Rain water.

You can collect rain water from a downspout during a storm. Let the first few gallons pass by, as this will probably contain contaminants from dust settled on the roof. Filter through a coffee filter paper. Then check for acidity with a simple aquarium pH test kit. These cost approx.. \$1.50 in Walmart. They contain a small vial and a bottle of test solution. pH is determined by the color comparison chart. As long as the water falls in the neutral range, it will be quite suitable for electroplating tanks. Alternatively, purchase a digital pH Meter from Caswell Inc.

Always use plastic or glass stirrers & containers. Warm the water before adding crystals, this aids them in dissolving.

### ALWAYS POUR ACIDS INTO WATER, NOT VICE VERSA.

Rinse everything off after use, to avoid cross contamination. Even the smallest amount of chrome introduced into a nickel tank can ruin it! Wear safety equipment, goggles, gloves, and apron. As soon as you have made up your solutions for the first time, you should mark the level of the liquid on the tank wall. You will need to refer to this line, when evaporation of the water takes place, at which time you will need to add more water.



If you add too much water, you can always remove it by evaporation. Heating the liquid will cause the chemicals to stay, and only the water to evaporate off. Evaporate down to your original mark. You may wish to periodically strain all your solutions through a coffee filter to remove sludge and debris. Add activated charcoal to the bottom of the filter. This will remove many contaminants.

## **SP Degreaser**

TO MAKE SP Degreaser

Add DISTILLED WATER to the tank

Add 8oz SP Degreaser powder to each gallon of water. Keep to this ratio for larger quantities.

Ideal operating temperature is between 140 -210 deg F.

Use a plastic tank and a ceramic heater. No thermostat is necessary. The hotter the solution, the better it works.

### **Using the SP Degreaser**

This process should not be used unless the part is oily, greasy or has fingerprints on it

The **SP Degreaser** tank can be used for two different reasons:-

#### **1. SOAK**

By soaking a greasy part in this solution for a period of time the caustic **SP Degreaser** will break down oil and grease.

#### **2. DIP**

A quick dip in the solution, usually after the part has been immersed in an acid, will neutralize the surface, and kill any remaining acid, which could cause dis-bonding problems.

Rinse the part in fresh hot water, carry out a waterbreak test and proceed immediately to plating. Do not allow the part to dry. Keep it suspended in fresh warm water whilst waiting for the plating bath.

As soon as the effectiveness of the SP Degreaser is diminished, dispose of the product by dumping into a drain, and replace with a fresh batch.

The use of SP Electrocleaner (now SP DEGREASER) using an electrical current for 'Electrocleaning' has been discontinued as a recommended technique.

## STRIPPING AND ETCHING PREPARATORY METHODS



Caswell Inc. has changed the procedure for several preparation techniques. Gone are the old pickles, #1, #2, and #3. They have been replaced by Nickel Activator, MetalX, and Anodize & Chrome Stripper and Pickle #4. The section concerning the various plating procedures will tell you which ones to use and when. All these techniques will remove either corrosion or old plate, the electro-stripping usually being faster and more dramatic. When there are only thin, delicate layers of plate or corrosion, soaking is preferred.

We do not supply the Sulfuric (Battery) acid, required to make up these solutions.

Sulfuric acid (Battery acid @1.27 SPECIFIC GRAVITY, or 33% concentration) can be purchased from any NAPA Auto Parts Store. Pure (98%) can be diluted to this by adding one part of acid to 2 parts of water. Make sure you add the acid to the water, not the other way around, otherwise it may explode in your face! All references to battery acid in this manual refer to 33% diluted sulfuric acid @ 1.27sg.

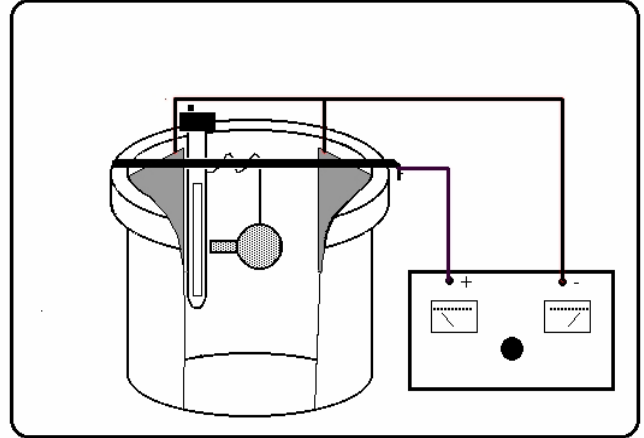

### 1. DIPPING.

The part is momentarily dipped into the solution.

### 2. SOAKING

When the Operating Procedures call for a soak, this means the part should be hung from a wire and immersed into the solution. No electric current is used. Soak times are posted in the Operating Procedures section. These chemicals usually operate faster when warmed to between the 140-180 deg. F range. However they will work as low as 70 degrees. .

### 3. ELECTRO-STRIPPING .

The introduction of an electric current through the part, dramatically increases the depletion of rust and old plate.

The relevant solution is introduced to a de-plating tank and the part suspended on a wire from the tank bar. The tank plates (cathodes) are wired to the negative side of your power unit and the tank bar to the positive. By varying the resistance, using bulbs or your rheostat, you can control the degree of de-plating taking place.

**WARNING! Always pour acid into water, NEVER POUR WATER INTO ACID!**



## ANODIZE AND CHROME STRIPPER

Removes chrome and anodize if the part is simply immersed in this solution for between five minutes and one hour. To speed up the process suspend the part from the TANK BAR using a copper wire and connect the cathode plates to the negative side of your power supply. Connect the tank bar to the positive side of your power supply. The chrome/cadmium will now de-plate itself. A milky white residue will form over the part. This can be washed off with fresh water.

THIS IS A VERY RAPID PROCESS, SO BE WATCHFUL THAT YOU DO NOT GO TOO FAR AND START TO DISSOLVE THE PIECE COMPLETELY.

### De-Plating using acid pickles

Stripping off old plating is a fairly easy procedure using the Electro-stripping tank and either sulfuric or Muriatic acid. However some care should be taken not to go too far and damage the part.

## NICKEL ACTIVATOR (Battery Acid)

This is the normal concentration of sulfuric acid i.e. 1.26 sg or 33% acid as sold by NAPA Auto Parts.

Nickel needs to be activated in some circumstances. When a nickel plate is old, dull etc. the surface may not take another plate on top, because of the oxide layer. Swabbing or immersing in battery acid for 30-60 seconds will etch the oxide layer off.

Nickel Activator should be used prior to gold plating the nickel surface. It should also be used when a regular nickel-plating procedure has been halted for whatever reason. If the power to the plating tank has been interrupted for even one second, the part must be activated before continuing, otherwise the subsequent nickel plate will delaminate.

It is unadvisable to use Nickel Activator on nickel-plated pot metal, in case there are areas that are un-plated. The acid will rapidly attack those areas.



## PICKLE # 4

For stripping rust from steel & also activates zinc, pot metal, lead, 60/40 solder, copper & its alloys.

No unpleasant fumes. More moderate action, less pitting.

This system is ideal for the preparation of lead work such as bullets, sun catchers, lead came, etc



PICKLE # 4 is a general-purpose metal activator and de-oxidizer containing fluoride and is used at room temperature on steel, copper, brass and zinc. It is a free flowing mixture of dry acids and is more convenient and safer to use than liquid mineral acids. It does not produce the undesirable fumes given off with strong acids.

Pickle # 4 is dissolved in water and used at ambient temperatures to remove light to medium surface rust from steel and to activate steel surfaces prior to blackening with Black Oxide blackening solutions. Heavily rusted surfaces may require elevated temperatures of 150°F to 170°F. No venting required when used at ambient temperatures. It is used following the water rinse after cleaning the steel surfaces with SP DEGREASER

PICKLE # 4 is more moderate in its action on steel surfaces than mineral acids and produces a uniformly active surface. It is also used to activate zinc-plated surfaces, die cast zinc surfaces, copper and copper alloy surfaces prior to blackening, oxidizing, antiquing, chromating or other finishing.

PICKLE # 4 solutions must be contained in acid-resistant tanks and containers. Polypropylene, polyethylene, PVC or rubber-lined steel are suitable. If heaters are required they must be glass, ceramic or Teflon coated.

Metal	Action	Makeup & Use
Steel	activation	8 oz/gallon 30 to 60 second immersion
	rust removal	16 to 32 oz/gallon 2 to 10 minutes immersion
Copper and its Alloys	deoxidizing	8 to 16 oz/gallon 30 to 60 seconds immersion
Plated and die cast zinc Lead/lead solder	deoxidizing	4 to 8 oz/gallon 30 seconds to 2 mins immersion

Residual PICKLE # 4 solution must be removed with a thorough cold-water rinse prior to further finishing. The strength of the solution is maintained by small periodic additions of PICKLE # 4 salts. The solution is dumped only when its effectiveness is diminished by accumulation of metals, dirt, oil, etc.



## **METALX METAL STRIPPERS**

MetalX strips nickel without electricity or dangerous chemicals. and is the only one-component, non-toxic, powdered, immersion nickel strippers on the market.

Removes NICKEL from steel, copper, brass and zinc die-cast, silver and gold.

**MetalX B-9** strips nickel from steel

**MetalX B-929** strips nickel from copper, brass, zinc die-cast, pot metal, silver and gold, without etching the base metal.

MetalX strippers will strip nickel at the rate of 2 mils per hour, (2/1000") and will strip 2.5-6 ounces of nickel per gallon of stripper solution. Electroless nickel will strip at the same rate, providing the phosphorous content does not exceed 5%. Higher phosphorous electroless nickel will take longer to strip.

2.5 lbs of MetalX stripper makes 1 gallon of stripping solution.

Use plastic, unlined steel or stainless steel tanks

Agitation is required during stripping

Stripping tank must operate between 120°F-150°F. To prolong bath life, heating should be discontinued immediately after stripping is complete.

Stainless steel or titanium heaters must be used. No quartz or ceramic heaters.

Instruction sheet is provided with the product, as this is a proprietary material not manufactured by Caswell Inc

## INTRODUCTION TO PLATING PROCEDURES

The following pages show the various plating set ups and procedures. You should use these pages in conjunction with the particular surface preparation methods and the METALS CHART. By doing this, you will be able to make a determination of exactly what you want to do.

There may be several ways to plate the same part. For example, a steel bolt in good condition may be nickel plated and polished to look like chrome, or it could be chrome plated on top of a nickel plate. Therefore, you must use this manual as a reference book, and you may need to refer to several plating methods to complete your project.

On each Plating Procedure page you will find a box showing you the settings for temperature and current, and the diagram at the foot of each page shows exactly how the system should be set up.

On some metals you may be instructed to apply a 'strike' coat. This is a thin layer of metal, applied as a primer to the main plate you wish to apply. It usually only takes a few minutes to apply. See the METALS CHART.

For example, our Bright Acid Copper plate cannot be directly plated to steel, it will not bond. So you need to apply a thin layer of FLASH COPPER first (this is the 'strike' coat), then apply the Bright Acid Copper to the nickel. You would be applying the copper plate (a filler) to enable you to carry out repairs to the steel. If there were no repairs to make, you would not need the 'strike' coat, so you would simply nickel plate, then maybe, chrome plate the part.

Example of a plating procedure, on a pitted steel part.

Degrease in the SP DEGREASER  
Rinse  
Pickle in PICKLE # 4  
Rinse  
Water Break Test  
FLASH COPPER for 10-15 mins (Strike)  
Rinse  
BRIGHT ACID Copper Plate for 30 + mins  
Rinse  
Solder any pits, Sand down

Buff with Emery & Sisal Wheel  
Degrease in the SP DEGREASER  
Rinse  
Water Break Test  
FLASH Copper Plate for 15 mins  
Rinse  
Buff to a high quality shine cotton/brown bar  
Degrease in the SP DEGREASER  
Rinse  
Water Break Test  
Nickel Plate for 45 mins  
Buff with cotton wheel & White bar  
Degrease with SP DEGREASER  
Rinse  
Water Break Test  
Chrome Plate  
Buff with Canton wheel and Blue bar  
Apply Collinite Metal Wax

Rinsing is a very important step. It MUST be done thoroughly.

## METALS CHART

The following chart gives you an overall concept of which metals can be plated with each kit, and the steps required.

Gold (not shown) should only go over a nickel or tin plate

Silver (not shown) should only go over a copper, nickel or tin plate.

A copper plate is considered a base metal, and so can be plated with nickel, copy chrome or tin

Nickel plate is considered a base metal, so can be plated with chrome, copper, tin, zinc, Copy Cad, Copy Chrome, gold & silver

Zinc & Copy Cad are acid sensitive, so must be plated with Flash Copper prior to being plated with Reg Nickel or Bright Acid Copper.

Base Metal	SP Degreaser	ETCH (Pickle)	Strike Coat	Flash Copper	Bright Acid Copper Plate	Regular Nickel/Copy Chrome	Chrome Plate	Anodize Aluminum	Zinc Plate	Yellow Chromate	Copy Cad	Tin
Aluminum	5-15 secs	Nickel Activator 10-40 secs	Zincate Then Flash Copper	yes	as required	15-60	3 mins	See Anodizing section				
Iron Steel	15-60 secs	#4 as required	Reg Nickel 10 mins Or Flash Copper	optional	as required	15-60 mins	3 mins		15-30 mins	5-30 secs	15-30 mins	15-30 mins
Stainless Steel	15-60 secs	#4 as required	Flash Copper		as required	15-60 mins	3 mins					
Pot Metal Zinc Die Cast	30-60 secs	None	Flash Copper or Zinc/Copy Cad	yes	as required		3 mins		15-30 mins		15-30 mins	
Brass Copper Bronze	as required	#4 1-5 mins	copper 10 mins		as required	15-30 mins	3 mins					15-30 mins
Nickel	15-60 secs	Nickel Activator 15 secs		optional	as required	5-15 mins	3 mins		15-30 mins		15-30 mins	15-30 mins
Chrome		Chrome stripper										
Plastic			Silvaspray Then Acid Copper		Yes	15 mins	2 mins					
Lead		Pickle # 4		Yes		yes	yes					
Pewter		Pickle # 4		Yes		yes	yes					

## **BRIGHT NICKEL & COPY CHROME PLATING**

To conserve space in this manual, we are using the same instructions for Copy Chrome and Bright Nickel, as the operating parameters are very similar. Copy Chrome has best results when used at room temperature, not 110 deg F, and requires lots of agitation, other than that, the instructions are the same for both.

### **MAKE UP THE SOLUTION.**

The chemicals are supplied pre weighed and ready to mix into distilled water. Take note of the mixing ratios marked on the bags.

Heat the required amount of distilled water to approx. 170 deg. f. This will aid the chemicals to dissolve.

Add the required amount of DISTILLED WATER to the tank.

Add the bag(s) of BRIGHT NICKEL or Copy Chrome CRYSTALS.







Stir the solution regularly as it cools, with a plastic or wooden stirrer.

You may have some chemicals settle to the bottom of the tank. They will eventually dissolve, although this may take several days.

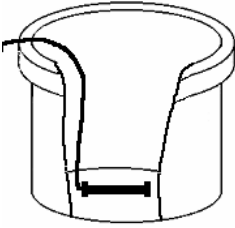
Do not operate the filter/agitator pump until all the crystals have dissolved.

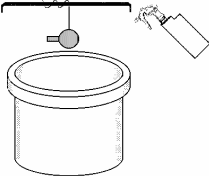
Leave the solution overnight to 'age' before using.

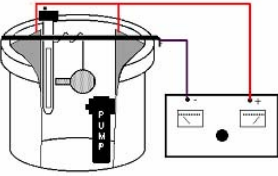
If available, check the pH with the digital pH meter and adjust the pH to 3.5 – 4.5

PROCEDURE	SETUP	OPERATING PARAMETERS	EQUIPMENT	SAFETY
1. SURFACE PREPARATION	Buff & Polish for a mirror finish. Bead Blast for a 'flat or Butler Nickel' finish. Nylon Abrasive wheel buff for a 'scratched brush' look. DO NOT ATTEMPT TO PLATE POT METAL DIRECTLY WITH THIS KIT (Prime first with FLASH COPPER)			
2. DEGREASING		140- 200 <sup>o</sup> F No agitation 5 mins immersion  12 oz SP Degreaser 3 gal Distilled water	1 x Plastic tank 1 x tank lid (1 x lid ring) 1 x 200f heater 1 x 2lb SP Degreaser	Wear rubber gloves and goggles. Do not ingest 
3. RINSE IN DISTILLED WATER SPRAY				
4. WATER BREAK TEST	  <i>Oil/dirt film makes water bead up</i> <i>No oil/dirt film allows water to cover part</i>			
5. CALCULATE TOTAL SURFACE AREA AND PLATING TIME				
6. Tank Makeup		110°F For Nickel 70°F For Copy Chrome Agitation (pump) 1 pack Crystals per 1.5 gals of DISTILLED WATER  Add 1 unit Brightener per bag of crystals  1 amp per 16 sq" for nickel 1 amp per 32 sq" for Copy Chrome  pH = 3.5 – 4.5	1 x 300W Heater 1 x Thermostat (For Copy Chrome, only use heater when solution is below 70°F. Remove heater when 70°F is reached) 1 x plastic tank 1 x tank lid (1 x tank ring) 2 Nickel Anodes 2 Anode Bandages 1 x filter/pump Crystals & Brightener Distilled water	Wear rubber gloves and goggles. Do not ingest 
PLATING CYCLE MUST NOT BE INTERRUPTED OR DELAMINATION OF SUBSEQUENT PLATING MAY OCCUR				
7. Plating Times	Immersion time depends on plating thickness			
	<b>Time</b>	<b>Application</b>	<b>Plate Thickness</b>	
	15 mins	Indoor items, decorative etc.	0.00025 "	
	30 mins	Hand tools, guns, nuts & bolts, brackets etc	0.0005 "	
	60 mins	Marine, motorcycle, car or outdoor fittings	0.001 "	
8. Replace lost water	After plating, top up the tank with DISTILLED water to the original waterline.			
9. Buff & Polish	Buff and polish to enhance the finish, using white buffing compound or Blue Begone Polish			
10. Wax	If the nickel is your finished product, apply a coat of Collinite Metal Wax			
11. CHROME PLATE	If you are to chrome plate the nickel: a. buff to a high shine b. degrease in SP Degreaser c. Water Break Test d. Proceed to Chrome Tank immediately			

## Nickel & Copy Chrome Plating Troubleshooting

<b>Problem</b>	<b>Cause</b>	<b>Remedy</b>
No deposit	No current (or gassing from part)	Check all electric
Plate peels off or blisters	1. Poor preparation 2. Inadequate cleaning	Check part with 'waterbreak' test. Acid etch part. Check SP Degreaser is OK. Chrome in nickel, if so, dump solution. On porous metal (Pot Metal) sand blast, Flash Copper, then Bright Copper & or nickel plate.
Pitted Plate and Orange Peel effect	1. Impurities in solution 2. Hydrogen bubbles formed on part	Strain through coffee filter with 1/2 of 'activated charcoal' in bottom. Add more Nickel Brightener.  Add 1-3 teaspoon of HYDROGEN PEROXIDE per 2 gals of nickel solution to reduce pitting  Alter agitation, or use manual agitation of the part.
Rough Plate	1. Amps too high 2. suspended particles in solution 3. pH too high or low	Reduce current 1 amp = 15 sq"  Filter solution (no charcoal). Clean filter  Adjust Ph to within 3.5- 4.5
Black streaks or dark deposits (esp. on low spots)	Zinc, lead or copper in solution (Especially zinc plate)	Plate out onto a dummy corrugated cathode. Zinc contaminants may show as alternating dark & light areas. Air agitation must be on.  Do not blast or abrade old zinc plating off metal. Use an acid pickle. Blasting causes zinc to penetrate into the metal.  Adjust pH to 3.5 - 4.5
'Burnt' Plate	Too much current	Lower the amperage  Raise the bath temperature
Haze on the plate	Excess Hydrogen Peroxide	Heat solution to 190 deg F, then filter using charcoal bag in the filter pump. Replace brightener
Bright plate on high areas only	Insufficient Brightener	Add Nickel/Copy Chrome Brightener
Bright plate except very low spots	Too much Brightener	Remove by filtering through charcoal, then replace
Dull Nickel Plate	1 Insufficient Brightener 2. Part not polished properly	Add brightener  Strip the plate off and re-polish, or plate with copper, polish the copper and then re-plate.
Dull Copy Chrome Plate	1. Temperature Too High 2. Insufficient Brightener 3. Part not polished properly	Lower temperature to 70 deg F  Add brightener  Strip the plate off and re-polish, or plate with copper, polish the copper and then re-plate.

## **ADDITIONAL TIPS**

**DO NOT REMOVE THE PART ONCE PLATING HAS STARTED.** You will interrupt the process causing the succeeding layer of plate to delaminate. If any interruption occurs, activate the surface by swabbing the surface with NICKEL ACTIVATAOR on a cotton swab.

Rinse the part in fresh water, then return to the plating tank to finish the application.

BRIGHT NICKEL & Copy Chrome plating is prone to forming little pin pricks in the surface caused by Hydrogen bubbles sticking to the plated surface. The plating then forms around the bubble, making a small crater on the surface. These are very unsightly and difficult to remove. Agitation from the filter pump removes the bubbles and supplies fresh solution to the plating surface. It will also make a smoother plate. This can also be achieved by blowing air into the solution.

For a high quality finish on brass, copper & bronze, apply a copper plate first, buff, then nickel or Copy Chrome plate. However, nickel or Copy Chrome will plate successfully directly to these metals.

For a flat finish on steel, sand blast with fine abrasive, then plate, do not polish before plating, only after to remove dull gray. The BRIGHT NICKEL finish can be made to look like Cadmium or a "Butler Nickel" used on Model A Fords.

To make nickel look like a cadmium plate sand blast the part to a dull flat finish, then nickel plate. Finish by scrubbing with wetted scouring powder such as VIM or Comet. You will get better results from our COPY CAD kit.

To make nickel look like the Butler Nickel finish, plate with the amperage turned up slightly and the temperature down. Clean up with scouring powder.

Use nickel plate as a 'strike' coat onto steel, prior to plating with copper. Acid copper systems such as ours, will NOT plate directly to steel or zinc, so they need to be covered with an 'inert' layer prior to plating. Either type of nickel system will act as this protective layer, preventing the acid from damaging the steel or zinc. Our preference is to use the FLASH COPPER system as this primer.

**DO NOT PLACE POT METAL, OR ANY TYPE OF ZINC/PLATED SURFACE IN BRIGHT NICKEL OR COPY CHROME SOLUTION.** The zinc from the pot metal will react with this more acidic solution, which will become contaminated and ruin any further work. Steel is not effected by this product and can be directly plated with it, however use caution when plating steel that has previously been zinc plated. Be sure to remove the zinc plating in an acid pickle. Blasting the zinc off sometimes causes zinc particles to penetrate into the steel, resulting in black streaks in the plating.

As soon as you have completed nickel plating, proceed immediately to chrome plating, if required. Copy Chrome will not require Chrome plating, as it is the finished job.

After plating with nickel or Copy Chrome, buff the part to a high shine using a spiral sewn wheel and white compound, then soak in hot SP Degreaser to remove buffing greases etc.

The shiny appearance of BRIGHT NICKEL or Copy Chrome plate can be enhanced by several factors.

1. Buffing and polishing PRIOR to plating, is by far the most important factor.
2. The addition of brighteners to the solution. NICKEL/COPY CHROME BRIGHTENER ADDITIVE should be added at the rate of 1 fl oz per gallon of solution when the system begins to lose brightness. These brighteners are in the initial mix of nickel solution. If the system is 'cleaned' by filtering through a charcoal filter (see troubleshooting), then additional brightener MUST be added to bring back the original plating conditions.
3. Buffing and polishing AFTER plating,
4. Protecting the surface by applying Collinite Metal Wax.

## ZINCATE INSTRUCTIONS

### Process for Plating Aluminum



Aluminum forms an oxide the moment it is exposed to the air. This presents a problem when plating it, as the oxide prevents the plate from sticking. By using the Zincate process as a preplate dip, you chemically remove the oxide layer and at the same time, apply a layer of zinc. The zinc protects the aluminum from further oxidizing until it is ready to be plated. As the part is lowered into the plating tank, the zinc is etched away by the solution and plating proceeds onto a clinically clean surface.

### Procedure for Zincating

Bead Blast clean the part to remove all heavy oxides and contaminants.

Buff and polish to the required shine. The part should then be thoroughly degreased in CASWELL SP Degreaser.

Make up a solution of Zincate by adding 25% by volume of the concentrate to a plating tank (Pyrex , plastic etc.) and fill with distilled water. i.e.:- Add 250 ml of Zincate, then top up to 1 liter mark with distilled water.

Heat the solution to 75 deg f. An aquarium heater will do this quite easily.

Immerse the part in the solution for 15 sec. to 2 minutes. **NO MORE!**

Immersion time will depend on the alloy, zincate condition and temperature.

If the alloy reacts violently with the solution, then shorten the time immersed.

If no reaction is visible, then immersion times can be extended.

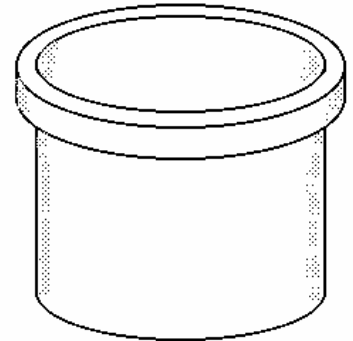

A uniform gray appearance is usually a sign of a properly zincated surface, however there are cases where a dark, slightly streaked surface is acceptable. As the Zincate solution is depleted, there will be a noticeable increase in the gassing. You can replenish the solution by adding about 10% of the Zincate concentrate, or simply make up a fresh batch.

Allow the part to drip dry or shake excess off and prepare for Nickel Plating in our **BRIGHT NICKEL** (with anodes & power supply), Electroless Nickel kit, Copy Chrome or Copper kit.

Because Brush Plating exposes the part to the atmosphere, it is virtually impossible to Zincate an aluminum part, then brush plate onto the Zincate. We suggest the part is electroless nickel plated, then it may be brush plated with almost any other finish.



## FLASH COPPER PLATING

Plates onto, LEAD, POT METAL, STEEL, PEWTER, ZINC, BRASS, ZINCATED ALUMINUM, STAINLESS STEEL, ELECTROLESS NICKEL, TIN AND COPPER.

Flash Copper cannot be plated over Silvaspray. The alkaline nature of the solution will act as a paint stripper. Use acid copper for Silvaspray coating.

FLASH COPPER is an outstanding pre-plate copper strike for bright nickel, acid copper, tin and solder plates. It eliminates the use of: Cyanide strike coats; Pot Metal Primer on Zinc; nickel strike on steel prior to copper plating. Ideal for 'priming the lead on fishing lures, and sun catchers, prior to plating with Nickel or Copy Chrome. Increases the bond of acid copper, nickel and Copy Chrome to all substrates.

FLASH COPPER is a unique alkaline electrolytic copper plating process with covering and throwing powers greater than cyanide copper. It is an excellent heat treat stop off plate and EMI shield. It is also an excellent decorative finish for buttons, rivets, lighting fixtures and builders' hardware. The copper plate can be readily blackened or oxidized for a variety of attractive antiqued finishes. There are no carbonates to be treated. It contains no strong chelators. It is supplied as a liquid concentrate, which is diluted with water.

FLASH COPPER produces a fine grained, smooth, dense and ductile copper deposit, which is nonporous and has excellent bonding properties. The throwing and covering power of the non-cyanide process is superior to cyanide processes. This is especially evident in barrel plating. It has uniform low current density distribution with excellent micro-throw.

The grain is smaller than cyanide copper, which increases the density of the deposit. This density provides excellent heat treat stop off and masking properties. The fine-grained FLASH COPPER deposit under nickel/chrome improves the overall corrosion resistance and helps to throw the nickel farther into the low current density areas.

FLASH COPPER produces a softer and more ductile deposit than cyanide or acid copper. The soft deposit imparts improved adhesion and corrosion resistance and greatly improved resistance to thermal shock.

It has a high deposit purity and hence no out-gassing with subsequent brazing, soldering or vacuum operations.

FLASH COPPER is simple and inexpensive to use because it replenishes the copper in solution by dissolving the copper anode and here again it is a unique product with only one maintenance additive.

PICKLE # 4, is a product for acid etching lead and solder. The pickle can also be used on most other metals.

### Making up the FLASH Copper Plating Solution

	1.5 gal kit	3 gal kit	4.5 gal kit
FLASH COPPER Part A	2 qts	4 qts	6 qts
FLASH COPPER Part B	1 pint	1 qt	3 pints
FLASH COPPER Part C	1pint	1 qt	3 pints
Distilled water	3 qts	6 qts	9 qts

Pour all ingredients listed above into tank. (note –simply empty the bottle of chemicals, and refill them with water, then add this to the tank)

Lead and pewter must be immersed in PICKLE # 4 for 2 minutes to remove the oxide layers.

### BATH MAINTENANCE

Normally no maintenance is required, other than topping up with distilled water.

Part A contained concentrated copper @ 2.4oz per gal. Only used for bath make up and occasionally when copper is depleted from solution, and dictated by Technical Support.







Part B is a 'replenisher' only used at initial bath make up and when dictated by Technical Support.

Part C is a pH adjuster and buffer. Use to adjust pH into the 9 – 10 range. Lower pH by adding battery acid, raise pH by adding part C.

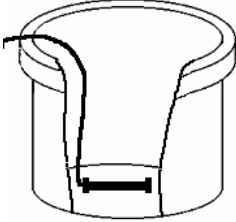
The Flash Copper bath must be operated with the filter-agitator pump operating with the air on for optimum performance.

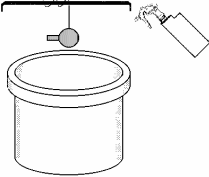

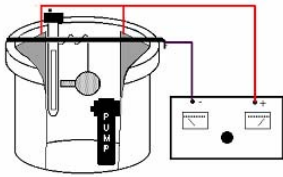
## FLASH COPPER PROCEDURE

PROCEDURE	SETUP	OPERATING PARAMETERS	EQUIPMENT	SAFETY												
1. DEGREASING		140- 200 <sup>o</sup> F No agitation 5 mins immersion  12 oz SP Degreaser 3 gal Distilled water	1 x Plastic tank 1 x tank lid (1 x lid ring) 1 x 200f heater 1 x 2lb SP Degreaser	Wear rubber gloves and goggles. Do not ingest 												
2. SURFACE PREPARATION	Sand/bead blast or Nylon Abrasive wheel. Degrease BEFORE bead blasting to avoid pounding grease into surface If required, buff, polish, THEN DEGREASE again.															
3. RINSE IN DISTILLED WATER SPRAY																
4. WATER BREAK TEST	  <i>Oil/dirt film makes water bead up</i> <i>No oil/dirt film allows water to cover part</i>															
5. CALCULATE TOTAL SURFACE AREA AND PLATING TIME																
6. Tank Makeup		110 <sup>o</sup> F Agitation (pump) Flash Cu A = 2qts Flash Cu B = 1 pt Flash Cu C = 1.pt per 1.5 gals of <b>DISTILLED WATER</b>  1 amp per 16 sq” 2 volts approx pH =9 – 10	1 x 300W Heater 1 x Thermostat 1 x tank lid (1 x tank ring) 2 Copper Anodes 1 x filter/pump Flash Copper A Flash Copper B Flash Copper C Distilled water	Wear rubber gloves and goggles. Do not ingest  												
7. Plating Times	Immersion time depends on plating thickness  <table border="0" style="width: 100%;"> <thead> <tr> <th style="text-align: left;">Time</th> <th style="text-align: left;">Application</th> <th style="text-align: left;">Plate Thickness</th> </tr> </thead> <tbody> <tr> <td>15 mins</td> <td>Primer over lead, pot metal, zinc</td> <td>0.00025 ”</td> </tr> <tr> <td>30 mins</td> <td>Primer over Steel</td> <td>0.0005 ”</td> </tr> <tr> <td>60 mins</td> <td>As a finished plate</td> <td>0.001 ”</td> </tr> </tbody> </table>				Time	Application	Plate Thickness	15 mins	Primer over lead, pot metal, zinc	0.00025 ”	30 mins	Primer over Steel	0.0005 ”	60 mins	As a finished plate	0.001 ”
Time	Application	Plate Thickness														
15 mins	Primer over lead, pot metal, zinc	0.00025 ”														
30 mins	Primer over Steel	0.0005 ”														
60 mins	As a finished plate	0.001 ”														
8. Replace lost water	After plating, top up the tank with DISTILLED water to the original waterline.															
9. Buff & Polish	Buff and polish to enhance the finish, using white buffing compound or Blue Begone Polish															
10. Wax	If copper is your finished product, apply a coat of Collinite Metal Wax, or VHT Clear Lacquer. Do not apply coating if you are going to apply further plates.															
11. Further Plating	e. You may plate with Acid copper to build thickness f. Plate with Nickel, then Chrome for a Triple Chrome Plate g. Plate with Nickel and finally Gold. h. Antiquing solutions for green or black or bronze patinas.															

### Flash Copper Plating Troubleshooting

<b>Problem</b>	<b>Cause</b>	<b>Remedy</b>
Discolored plating, chalky, brick red to black and sometimes peels off.	Organic contamination dragged in from cleaners or due to poor cleaning and rinsing.	Change carbon filters. Improve cleaning and rinsing.
Non-adherent plating, particularly in LCD areas or upon bending.	<b>Low Flash Copper Part B</b> Poor cleaning and surface preparation.	Add 1 - 2% by volume at a time Ensure proper soak, electroclean and acid or acid salt along with good, counter-flow rinsing.
Copper plating adhesion okay but copper and nickel plated parts, upon bend testing fail	<b>Low Flash Copper Part B</b> Low pH Copper metal too high	Add 1 - 2% by volume at a time and check Hull Cell plating results. Carry out adhesion tests. raise pH to 9.8. Lower the copper metal by plating out of bath using graphite or stainless steel anodes or a combination of copper and graphite and/or stainless steel anodes.
No deposit	No current (or gassing from part)	Check all electrics
Pitted Plate and Orange Peel effect	Impurities in solution	Plate a dummy for 30 mins. Clean pump filter.
Rough Plate	1. Amps too high 2. suspended particles in solution 3. pH too high or low	1. Reduce current 2. Filter solution through a carbon filter 3. Dump solution and make a new batch Check anode bags are not torn etc.
Dark deposits (esp. on low spots)	Zinc, lead etc. in solution	Plate a dummy for 30 minutes. With High current)
Dark, spongy deposits in HCD areas accompanied by poor adhesion in LCD areas.	Iron contamination	Use a good 2-3 stage counter flow rinse after acid pickling and before plating to minimize acid and iron contamination to the plating bath. HCD dummy plate to remove iron.
'Burnt' Plate	Too much current Copper levels too low	Reduce current, check solution temperature and reduce if needed. Add 1-2% Flash Copper Part A
Black non-adherent plating in HCD areas.	Lead contamination from leaded brass or leaded steel parts being plated	HCD dummy plate to remove lead on a periodic basis. Improve counter current flow rinsing to avoid drag in of dissolved lead. Check for parts dropped into tanks.
Cloudy deposits on the plate	1. Poor cleaning/rinsing 2. Organic contamination 3. High temperature 4. Low agitation	1. Improve cleaning/rinsing 2. Filter solution through a coffee filter 3. Adjust temperature 4. Improve air agitation
Dull plate	1. Too much amperage 2. Part not buffed enough	1. Reduce amperage 2. Buff and re polish
Plate Peels or Blisters off	1. Current too great 2. Surface too hot when buffed 3. Poor surface preparation	1. Reduce amperage 2. Reduce pressure on Buffing wheel 3. Improve technique
Plate peels or blisters off when applied to nickel base	1. Nickel has oxidized 2. Insufficient cleaning 3. Too much power whilst plating	1. Prior to plating swab nickel base with battery acid, then rinse. 2. Reappraise cleaning methods – use Soft Scrub etc 3. Reduce amperage. 4. check cleanliness using 'water break test'.
Blistering/loss of adhesion on zinc die-cast surfaces	Zinc contamination	Dummy plate out the zinc at <u>low</u> current density.

## NEW BRIGHT ACID COPPER PLATING INSTRUCTIONS



Copper plating can be used for several operations. This soft metal can be applied in thick layers that can be sanded, soldered and polished to a high shine, making its use somewhat like a high build filler paint coat. It may also be used to 'electroform' articles in various ways, and to 'bronze' non-conductive items such as leaves and baby shoes.

### Making up the Copper Plating Solution

See Copper Crystals bag for ratios. Bags are marked with water quantities (Approx 2.5 lbs of Crystals per 1.5 gal of solution)



Per 1.5 Gallons of Solution:

- Pour 1 gal and 3 pints (176 fl oz or 5.2L) of distilled water into the tank
- Install and start agitation pump
- Add one bag of copper crystals (2.5 pounds)
- Add 1 pint (16 oz, 473 mL) of battery acid
- Add 1.5 oz of Copper Brightener A (1 bottle)
- Measure out 0.3 oz of Copper Brightener Part B and add to tank. Store the remainder for adding to tank when required.

Plate a piece of scrap brass or copper about 15 sq. ins surface area for approx. 1 hr with 1 amp. This will expel any impurities from the solution.







Our acid based Copper Plating System is designed to apply heavy layers of copper, which can be sanded, soldered and/or burnished. It will only plate directly onto copper, brass, bronze, Copy Chrome and nickel. Do NOT attempt to plate steel, pot metal or aluminum without first applying a 'strike' coat of the appropriate metal. See the METALS CHART for more information

To apply a more even layer over rough surfaces, we have found it is best to remove the part from the tank and sand down with wet & dry paper, then return to the tank for more plate. This gives a more even plate than trying to apply all the copper at once. Buffing between layers will also help to produce a high quality finish.

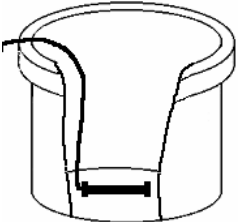
Copper will plate quickly, and if left too long will grow nodules and trees resembling coral growths on the part. These are fairly hard to remove. Agitation and a lower current will reduce the amount of buffing required. You may remove the part from the tank frequently, with no adverse effects to the successive layers of plate.

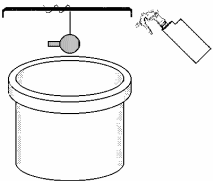
Although the average plating time is 15-20 minutes, copper may be plated for several hours if a really heavy layer is required. For a finer, denser plate, increase the tank temperature using the aquarium heater, and reduce the amperage. If the copper plate looks dark and is rough, or has a layer that rubs off, you will need to reduce the amperage during plating. Ideally, the color of good copper plate is a 'salmon pink'

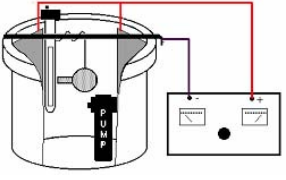
Copper Brightener Part B is consumed by the system. To maintain brightness, add small amounts (0.1 – 0.3 oz) of Copper Brightener Part B when required. Technical consumption is 1 quart of Part B per 2000 amp hours.

PROCEDURE	SETUP	OPERATING PARAMETERS	EQUIPMENT	SAFETY								
1. DEGREASING		140- 200 <sup>o</sup> F No agitation 5 mins. immersion  12 oz SP Degreaser 3 gal Distilled water	1 x Plastic tank 1 x tank lid (1 x lid ring) 1 x 200f heater 1 x 2lb SP Degreaser	Wear rubber gloves and goggles. Do not ingest 								
2. SURFACE PREPARATION	Sand/bead blast or Nylon Abrasive wheel. Degrease BEFORE bead blasting to avoid pounding grease into surface If required, buff, polish, and THEN DEGREASE again. If surface has already been plated with Flash Copper, then simply spray rinse twice and begin plating.											
3. RINSE IN DISTILLED WATER SPRAY												
4. WATER BREAK TEST	  <i>Oil/dirt film makes water bead up</i> <i>No oil/dirt film allows water to cover part</i>											
5. CALCULATE TOTAL SURFACE AREA AND PLATING TIME												
6. Tank Makeup		70-90 <sup>o</sup> F Agitation (pump) Copper Crystals 2.5lb Battery Acid 16 fl oz 176 fl oz DISTILLED WATER 1.5 oz Cu Bright A 0.3 oz Cu Bright B 0.07 – 0.2 amps/sq in 2-5 volts approx pH = 1.2 -1.7	1 x Glass Heater 1 x tank lid (1 x tank ring) 2 Copper Anodes 2 Anode Bandages 1 x filter/pump Copper Crystals Cu Brightener A&B Distilled water	Wear rubber gloves and goggles. Do not ingest  								
7. Plating Times	Plating thickness is dependant on both amperage and time. Rapid build up can be achieved by increasing the amperage, but overdoing it will produce a dark brown plate, with gritty copper nodules. These are loosely bonded and will wipe off. There is a huge operating range here, and practice is essential.  <table border="0"> <tr> <td><b>Time</b></td> <td><b>Plate Thickness</b></td> </tr> <tr> <td>15 mins</td> <td>0.00025 ” - 0.0005 ”</td> </tr> <tr> <td>30 mins</td> <td>0.0005 ” - 0.001 ”</td> </tr> <tr> <td>60 mins +</td> <td>0.001 ” - +</td> </tr> </table>				<b>Time</b>	<b>Plate Thickness</b>	15 mins	0.00025 ” - 0.0005 ”	30 mins	0.0005 ” - 0.001 ”	60 mins +	0.001 ” - +
<b>Time</b>	<b>Plate Thickness</b>											
15 mins	0.00025 ” - 0.0005 ”											
30 mins	0.0005 ” - 0.001 ”											
60 mins +	0.001 ” - +											
8. Replace lost water	After plating, top up the tank with DISTILLED water to the original waterline.											
9. Buff & Polish	Buff and polish to enhance the finish, using white buffing compound or Blue Begone Polish If adding nickel/chrome etc. Degrease and carry out the ‘Water Break Test’											
10. Wax	If copper is your finished product, apply a coat of Collinite Metal Wax, or VHT Clear Lacquer. Do not apply coating if you are going to apply further plates.											
11. Further Plating	i. Plate with Nickel, then Chrome for a Triple Chrome Plate j. Plate with Nickel and finally Gold. k. Antiquing solutions for green or black or bronze patinas.											

## Copper Plating Troubleshooting

<b>Problem</b>	<b>Cause</b>	<b>Remedy</b>
No deposit	No current (or gassing from part)	Check all electrics
Pitted Plate and Orange Peel effect	Impurities in solution	Plate a dummy for 30 mins. If no improvement, filter solution through activated charcoal placed into a coffee filter, then replace the Brighteners (You will have to order new A & B brighteners)
Rough Plate	1. Amps too high 2. suspended particles in solution 3. pH too high or low	1. Reduce current 2. Filter solution through a coffee filter (No charcoal) 3. Dump solution and make a new batch Check anode bags are not torn etc.
Dark deposits (esp. on low spots)	Zinc, lead etc. in solution	Plate a dummy for 30 minutes.
'Burnt' Plate	Too much current	Reduce current, check solution temperature and reduce if needed.
Cloudy deposits on the plate	1. Poor cleaning/rinsing 2. Organic contamination 3. High temperature 4. Low agitation	1. Improve cleaning/rinsing 2. Filter solution through activated charcoal placed into a coffee filter, then replace the Brighteners (You will have to order new A&B brighteners) 3. Adjust temperature 4. Improve air agitation
Dull plate	1. Too much amperage 2. Part not buffed enough 3. Brighteners Exhausted	1. Reduce amperage 2. Buff and re polish 3. Add Copper Brightener B
Plate Peels or Blisters off	1. Current too great 2. Surface too hot when buffed 3. Poor surface preparation 4. Plated onto steel	1. Reduce amperage 2. Reduce pressure on Buffing wheel 3. Improve technique 4. Prime steel with nickel before copper plating
Plate peels or blisters off when applied to nickel base	1. Nickel has oxidized 2. Insufficient cleaning 3. Too much power whilst plating	1. Prior to plating swab nickel base with battery acid, then rinse. 2. Reappraise cleaning methods – use Soft Scrub etc 3. Reduce amperage. 4. Reverse the current for 60 seconds to 'etch' the surface of the part.

## **BRONZE PLATING**







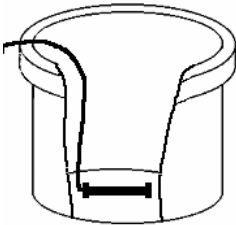

Caswell's Bronze Plating Solution is an easy to use, one step system that plates a rich bronze finish over most metals. It does not contain cyanide, or any other harmful chemicals.

The bronze plating solution will deposit over zinc, pot metal, pewter, nickel, copper, steel, sintered metal, tin, lead, stainless steel and zincated aluminum.

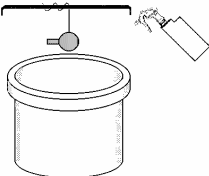
### **MAKE UP THE SOLUTIONS**

The bronze plating solution is provided pre-mixed and ready to use. Other chemicals are supplied pre weighed and ready to mix into distilled water. Take note of the mixing ratios marked on the bags.

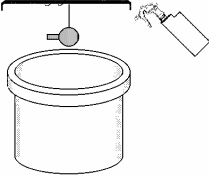
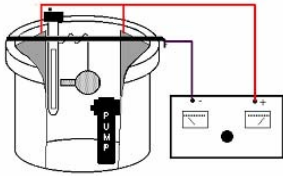
Pour the supplied amount of bronze plating solution into the tank. Install the heater and filter pump. Heat the solution to 80°F before using.

PROCEDURE	SETUP	OPERATING PARAMETERS	EQUIPMENT	SAFETY
1. SURFACE PREPARATION	Buff & Polish prior to plating for a mirror finish.			
2. DEGREASING		140- 200 <sup>o</sup> F No agitation 5 mins immersion  12 oz SP Degreaser 3 gal Distilled water	1 x Plastic tank 1 x tank lid (1 x lid ring) 1 x 200f heater 1 x 2lb SP Degreaser	Wear rubber gloves and goggles. Do not ingest 
3. RINSE IN DISTILLED WATER SPRAY				
4. WATER BREAK TEST	 Oil/dirt film makes water bead up		 No oil/dirt film allows water to cover part	
5. OPTIONAL ACID ETCH		Room temperature 30-60 seconds  Recommended when plating onto steel, old nickel plate, zinc, die cast, lead and pot metal.	Pickle #2 (or 3-20% Hydrochloric Acid) for steel and old nickel.  Pickle #4 for zinc, lead, die cast and pot metal.	Wear rubber gloves and goggles. Do not ingest 
6. RINSE IN DISTILLED WATER SPRAY		Only required if optional acid etch step was performed.		
7. CALCULATE TOTAL SURFACE AREA AND PLATING TIME				
8. Tank Makeup		80 <sup>o</sup> F Agitation (pump) Bronze Plating Solution (Ready To Use)  0.1 Amps Per Square Inch  3 volts  pH = 7.6	1 x 300W Heater (Heat solution to 80 <sup>o</sup> F. Unplug heater when 80 <sup>o</sup> F reached.) 1 x plastic tank 1 x tank lid (1 x tank ring) 2 Stainless Steel Anodes 1 x filter/pump Bronze Solution	Wear rubber gloves and goggles. Do not ingest 
9. Plating Times	Immersion time depends on plating thickness. Deposition rate is approx 0.0075/hour.  <b>Time            Application</b> 2-3 mins        Decorative items that will be clear coated 30-40 mins     If buffing is desired after plating			
10. Replace lost water	After plating, top up the tank with CITY water to the original waterline.			
11. Buff & Polish (optional)	Buff and polish to enhance the finish, using brown buffing compound.			
12. Clear Coat (optional)	To increase corrosion resistance of plated finish, it is recommended to apply a clear coat.			



## **Bronze Plating Troubleshooting**

<b>Problem</b>	<b>Cause</b>	<b>Remedy</b>
No deposit	No current (or gassing from part)	Check all electrics
Plate peels off or blisters	1. Poor preparation 2. Inadequate cleaning	Check part with 'waterbreak' test. Acid etch part. Check SP Degreaser is OK.
Part has whitish deposit on High Density Areas	Amps too high	Reduce current
Part has red in Low Density Areas	Amps too low	Increase Current
Part has milky appearance after lacquering	Plating time too long	Reduce plating time
Change in color or rate of deposition	Low bronze content in bath	Dump bath and made new batch.

## **DISPOSAL OF BRONZE PLATING SOLUTION**

### **Electro-Winning**

The bronze can easily be plated out using scrap iron or steel nails. The bronze metal in the bath can be reduced to levels acceptable to local authorities.

### **Precipitation**

Precipitation of the bronze metal can be achieved by raising the pH to 10-11 using sodium hydroxide or by lowering the pH with Hydrogen Sulfitite to 3-4. Using either method, the copper and tin metals in the bath will drop out of the solution. It may then be disposed of accordingly.

## DECORATIVE CHROME PLATING

Chrome plating has, until now, been one of those mystical arts that is followed around by all sorts of tales, regarding the difficulties of doing the job, yet in fact, the process is no more difficult than any other plating procedure. The most common 'tale of woe' is that of safety and disposal of the chemicals, and we will address both of those topics now.

In all kits containing chrome, we have provided a commercial chemical safety blanket and fume control balls, to virtually eliminate fumes from the plating tank. Providing you wear gloves, have adequate ventilation (a backup fume hood or respirator), and practice good housekeeping, you will have no problems.

To check that the tank is not emitting fumes during its operation, simply hold a sheet of white paper horizontally about 6" from the surface., for about 30 seconds. On removal, the sheet should be clean, with no brown stains. If it is stained, add more Mist Suppressant.

Read the MSDS at the back of this manual.

We are dealing with very small quantities of chemical compared to the plating shops, so the problems of disposal are almost non-existent. The chromic acid has such a large amount of real chrome in it, that it usually takes several years for most of our customers to use it up, so, it is infrequently disposed of. We now have a new 'chrome disposal kit' which you add to your old chrome to 'neutralize it', after which you can flush it down a drain.

Providing you follow the instructions explicitly, we believe any danger in the usage of these chemicals will be minimized and much satisfaction will be derived from your efforts.

### Safety First

During chrome plating, the vigorous bubbling action around the work-piece can send large quantities of pure chromic acid mist into the air unless proper procedures are taken. This mist is dangerous, carcinogenic and very unpleasant to breathe in, so certain measures **MUST** be taken before starting to plate. All of our chrome plating systems are supplied with Chrome Mist Suppressant, a chemical which is poured into the chrome tank. This, along with the mist control balls, makes a 'blanket' over the chrome, preventing most of the fumes/mist from escaping. See the section on safety procedures for more details.

If you inadvertently get a quantity of the acid on your skin, (chromic acid will stain your skin a 'nicotine' yellow), carry out the procedure outlined in the material safety data sheet. To remove the stain, gently rub the affected part with a bleaching scouring powder like VIM or COMET. This will also remove some stains on work surfaces etc.

Always- always - wear gloves, an apron, respirator and goggles when handling chromic acid.

Chrome plating uses much more power than all other forms of plating, so consideration has to be given for a source of power adequate to bring the plating tank up to the 'operating window' requirements. Usually smaller items are easily plated from a car battery, (up to 50 square inches in surface area) but larger items, say up to 200 square inches, require planning and organizing of the power source. See the section on Power Requirements.

Most people fail to get a good chrome plate simply because they fail to appreciate the **HUGE** difference in power requirements from all other forms of plating. The chrome tank is also deceptive to watch, as it bubbles much more vigorously than the other tanks, so it appears that everything is working well, yet no plate appears. Operators simply need to turn up the power to get the tank into the 'operating window'!

There are two type of Chrome Plating:

1. Decorative Chromium Plating
2. Hard Chrome Plating

The application for each procedure is different. Decorative chrome is usually applied in a very thin layer, over a nickel plate, taking only 2-4 minutes to plate, and Hard chrome is applied straight to the base metal at the rate of .75 to 1.2 mil per hour of plating. Different concentrations of chromic acid are required, so you will need to make separate baths for each system.



**Decorative Chromium Plating** can be likened to a 'clear coat' on a paint job. It is a very thin layer of a bluish hue metal, which is applied over a nickel plate, the nickel plate being 'the paint job'. Chromium has very poor corrosion resistance as, if applied on its own, it is very porous. It has a cracked, porous appearance when examined under a microscope. Nickel, on the other hand, is very corrosion resistant, but it tends to slowly lose its shine unless polished occasionally. By applying chrome over nickel, we obtain the best of both worlds, high corrosion resistance and longevity of shine. To distinguish nickel from chrome you should look for the yellowish/gold hue of nickel and the bluish tint of chrome.

Decorative Chromium is applied in an extremely thin layer over nickel, approximately 1/100th the thickness of a hair, or 0.000001". This procedure takes only 2-4 minutes, unlike most other plating techniques, but there are several real differences in the application, such as the high current and accurate temperature requirement.

### Making up the NEW Decorative Chrome Solution

We have made a major improvement to our DECORATIVE CHROME PLATING system. This new formula has a much wider operating range than the previous system, making the system more tolerant of temperature and amperage.

The NEW DECORATIVE CHROME PLATING system is not suitable for HARD CHROME applications. You must use the original Hard Chrome formula to do this job – see below for instructions.

The DECORATIVE CHROME PLATING system comes with a 35 oz pack of chrome crystals and a 4 oz bottle of CHROME PLATING CATALYST. This catalyst contains everything needed to run the system, including the EPA compliant MIST SUPPRESSOR, sulfuric acid and catalyst. You only need to add 1.5 gal of distilled water to the Chrome Crystals and the catalyst.

### For the NEW Decorative Chrome Plate

- Add 1.5 US gal of DISTILLED water to the tank.
- Add 1 x 4 oz bottle of CHROME PLATING CATALYST
- Add 1 x 35oz can of DECORATIVE CHROME CRYSTALS



### Operating The NEW Decorative Chrome System.

Before you start to use this system, make sure you have adequate ventilation, and a fume control system in place.

The operating parameters of decorative chrome are much more restrictive than any other type of plating. We suggest that you do some trials using clean copper tubing to gain some experience. The difference in the color of the copper and the chrome finish makes it easy to ascertain if you have been successful.

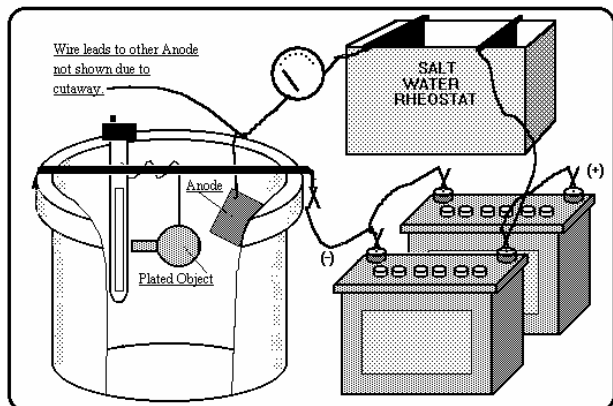

TANK TYPE	Plating
SOLUTION TEMP RANGE (Deg F)	105- 115
AIR AGITATION	NO
PLATING TIME (Minutes)	1-3
ANODE	12" x 12" chrome Plate
ANODE BANDAGE	NO
VOLTS ON VOLTMETER	3-5
AMPS REQUIRED PER SQ INCH	0.75 – 1.5
FUME HOOD	YES
USE AS STRIKE COAT	NO

The main factors to consider are temperature and amperage. Usually, if these are correct, then the part will plate almost instantly. If no plate has occurred within 2 minutes, re-appraise the situation and make adjustments. Chrome plating consumes HUGE amounts of current compared with all other types of plating. Your setup will require thicker wires to cope with this extra current. Usually jumper cables will accommodate most setups. If any wires get hot, then increase their size. The use of an ammeter to monitor amperage is highly recommended. This should be placed between the rheostat and the anodes –see diagram above.

A 25 amp rectifier will plate approx 15- 20 square inches of decorative chrome. This will replace the two batteries, the salt-water rheostat and the ammeter in the above diagram. Any items larger than that will require a larger power source. The most economic way of doing this for plating occasional items is to use one or two large 12 volt batteries, and control them with a salt water rheostat.

Chrome has poor throwing power, so don't place a small object into a large tank, without placing it close to the anodes. If needs be, reshape the anode around the part. (See Hard Chroming instructions for ideas on anode placement). You may only decorative chrome plate onto a GOOD, polished shiny nickel plate.

Each time you start up the chrome tank, plate a large piece of clean scrap metal or a 'dummy' for about 2 minutes. This 'charges' the tank and removes any impurities. With larger items, it is advisable to immerse them in hot water prior to plating. This brings their temperature up to the plating bath tank temperature, and therefore does not chill the solution, which would probably drop it to below its optimum operating range.

Chromium is deposited from the solution, not from the anodes. If you intend to plate hundreds of items, it may be advisable to take a specific gravity reading of your solution. Later, as the bath is depleted of chrome, you may add small quantities of chromic acid crystals to maintain the reading. Alternatively, as there is enough chrome to plate 200+ sq feet per gallon, you may wish to simply dispose of the solution and make up another batch, thus ensuring you have a fresh bath.

Chromic acid does not rinse well from parts. You can assist the rinsing process by using a squeeze/spray bottle filled with distilled water. Spray the water over the part and catch the runoff in your chrome distilled water tank.

Avoid getting chromic acid in your other plating tanks, as it will ruin them. If the plate is unsatisfactory, you may remove it without damaging the underlying nickel plate, by swabbing with Muriatic acid. Lightly buff the part prior to re-applying the chrome.

A 'dummy' pictured right, can be made of steel, copper or brass. It should be made approx 4"x 6" with 1" bends



## GENERAL HARD CHROME PLATING INSTRUCTIONS

The following instructions apply to all cases of Chrome plating with the exception of non-ferrous metals special alloys and mirror surface finishes in which cases the stripping operation should be omitted.

DO NOT STRIP NON-FERROUS METALS IN Chrome solution.

See Chart on "Rate of Deposition" and "Current Densities" following these instructions.

Before plating make sure your power is switched off and any rheostat control is turned to low.



1. Estimate the square inches of the work surface area to be plated.
2. Attach cleaned work securely to tank bar, being careful not to touch the surface to be plated.
3. Locate work in the approximate center of tank and raise or lower the liquid level adjuster so that the bottom of the work rests on the adjuster platform. Ensure solution level is approximately 1/8" above the top of the surface to be plated. Then, tighten work arm screw.
4. Set your power supply in the "STRIP" position (Anode wired to negative), and turn the power on. Adjust current to one amp. per sq. in. of surface to be plated and maintain this current value for approximately 10 seconds.
5. Reverse the wiring so that the anode is wired to the positive, or is in the "PLATE" position and increase current to one amp per sq. in. of surface to be plated. Plate work at this current for one minute. Next, increase current to 2 amps. per sq. in. of surface to be plated and maintain this current until the desired thickness of Chrome plate is attained.

**IMPORTANT:** All timing calculations referred to by "Rate of Deposition Chart" are based on 2 amps. per sq. in. current density and timing required for the desired deposit thickness should start when plating at 2 amp. per sq. in. current density starts.

6. After the required time interval has elapsed, reduce current density to equal 1 amp. per sq. in. and change terminals to 'reverse plate'. Allow work to remain in bath for 10 seconds and switch off the power supply.
7. Remove work and rinse it thoroughly in clean water.

## **DEVELOPMENT OF HARD CHROME SOLUTION**

Hard CASWELL Chrome plating solution has been developed specifically for use by the metal working industry, for the purpose of extending the life of cutting tools and wear parts. The simplicity and economy of operation makes it possible for the average machinist and tool engineer to accomplish industrial CASWELL Chrome plating within the confines of his own shop and without previous plating experience or knowledge.

This is possible because:

1. CASWELL Chrome Plating solution requires no periodic chemical analysis and adjustment.
2. CASWELL Chrome plating is fast. The standard rate of deposit, (.002 in. per hr.) at a current density of 2 amps per sq. in. remains constant during the full life of the plating bath. Average plating time in most cutting tool applications is 3 minutes in which time a thickness of CASWELL Chrome plate .0001 in. is deposited.
3. Operation is simple and economical. The average cost of plating is approximately 7 mils, per square inch, per .002 in. deposit.
4. CASWELL Chrome solution operates at room temperature (65 to 90F).

In general, a 300 to 400 per cent increase in cutting tool life is not unusual with the application of CASWELL Chrome plate.

The hardness of Hard Chrome plate depends on several factors including the characteristics, finish and hardness of the base metal. The term "hard" Chrome is a misnomer since all electro deposited CASWELL Chrome is hard. The hardness of Hard Chrome plate ranges from 650 to 850 Bhn.

The hardness factor in industrial Hard Chrome plating is not as important in its practical application as some believe. In fact, the association of the term "hard" with industrial Hard Chrome plating is misleading and therefore responsible for a great amount of misconception and misapplication.

More important to the efficient performance of cutting tools and wear parts are the other properties of Hard Chrome plate, such as the low coefficient of friction, resistance to seizure, high heat and corrosion. These factors and only these factors determine the efficiency of cutting tool and wear part performance.

The hardness of the Hard Chrome deposit is incidental in this case.

As an example, a cutting tool manufacturer does not process his cutting tools to their maximum possible hardness. Instead, he lowers the hardness of the tool to obtain toughness, wearing ability and resiliency and to reduce the brittleness of the tool, a condition extremely detrimental to good tool performance. The same is true of CASWELL Chrome plate since the same principles and reasoning apply. "Hard", brittle Hard Chrome plate is not the answer to increased tool performance.

### **The Importance of Base Metal Finish and Preparation (Prior to Plating)**

Basically, the smoother the base metal surface of the tool or wear part to receive CASWELL Chrome plate, the greater the efficiency in performance.

Since excessive friction is the prime reason for excessive tool wear and breakage, Hard Chrome plate cannot be expected to increase the efficiency of the tool or part if the cause for excessive friction has not been removed before plating.

To reduce friction and heat in the practical application of the tool or part and thus eliminate the cause of most tool failure, it is recommended that the tool or part be finished or polished to as good a base metal finish as is practical from an economical standpoint -- and in all cases, before applying Chrome plate.

CASWELL Hard Chrome plate will follow the exact surface characteristics of the base metal; thus, the smoother the base metal surface -- the better the wearing qualities of the plate. This diagram shows a comparison between smooth and rough base metal finishes and the hazards associated with plating over a rough base metal surface.

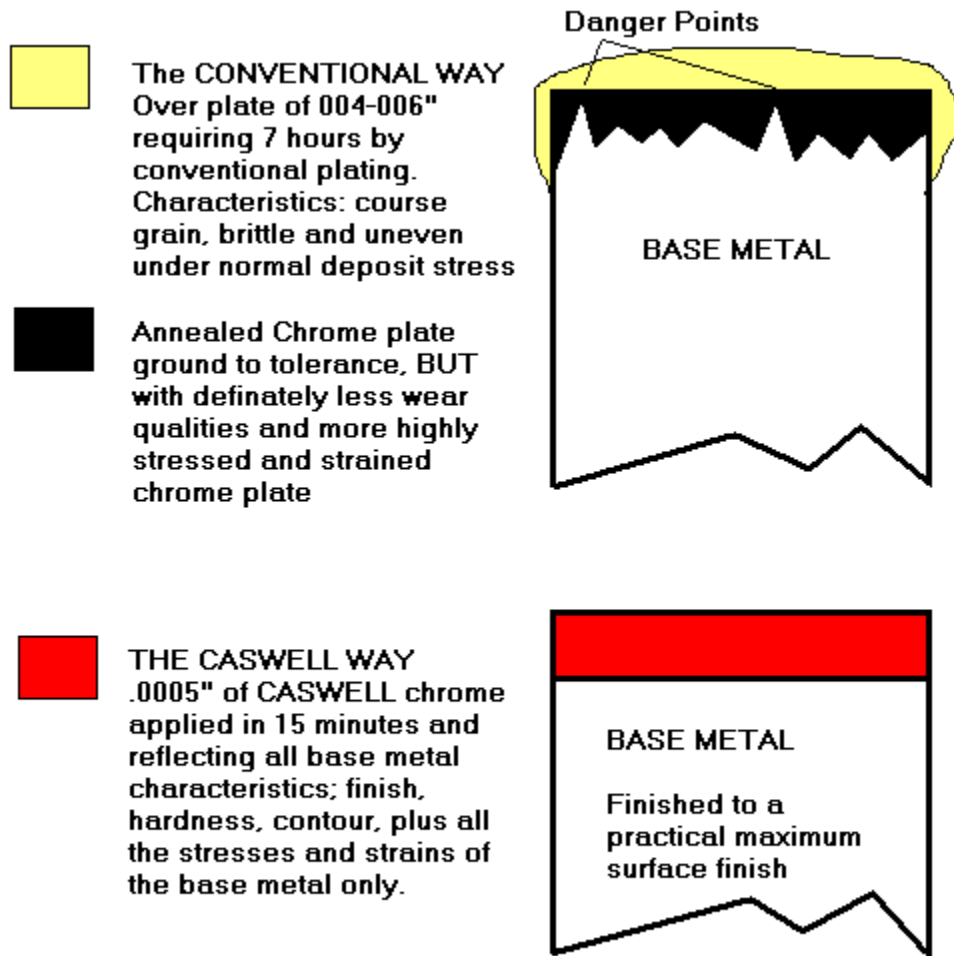

fig 4

Contrary to some thinking, a rough base metal finish does not provide a better bond between the base metal and the plate.

In effect, rough base metal surfaces can be likened to grinding marks, shown below, which set up friction and subsequently grind through the chromed surface.

## Reasons for Tool Failure

For maximum tool performance, rough grind marks should be removed prior to plating by lapping or polishing

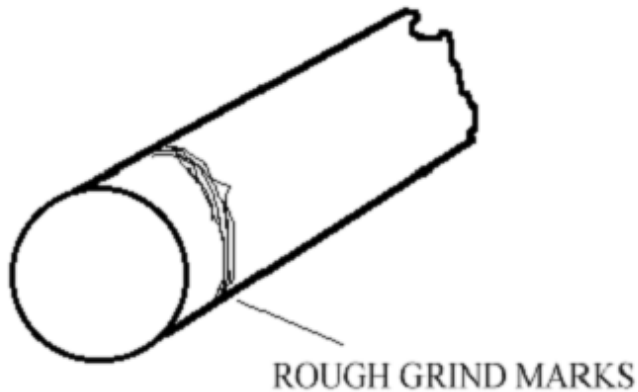

fig 5

Tool finishes normally supplied by most cutting tool manufacturers can be considered sufficient finish for the application of CASWELL Chrome plate.

The following precautions for the prevention of faulty Chrome plating should be observed:

### 1. Oil Impregnation.

Tools and parts which in their normal application, work in coolant oil, are subject to a certain amount of oil impregnation dependent on the type of steel used.

Depth of oil impregnation will range from .010 to .020 inches, and it is necessary that this oil be removed prior to plating.

This condition can ordinarily be rectified by immersion in carbon tetrachloride or by use of standard commercial degreasing methods. In extreme cases, however, it is recommended that the tool or part be heated to a temperature of 300 to 350 degrees F for a period of approximately two hours. The recommended cleaning and plating procedure should then be followed.

### 2. Highly Stressed Metals.

High stress and strains created by the natural forming and processing of any tool or part has the tendency to localize when subjected to exterior strains or forces.

In the electro-deposition of chrome, the CASWELL Chrome plate is deposited under stress. For this reason, in the plating action, the stresses and strains localize at the surface of the base metal. At times, this condition is difficult to recognize with the naked eye (in many instances not until the part has been plated). Plating will reflect and magnify base metal surface defects. These may be in the form of heat checks or fractures.

High stresses and strains are more likely found in tools and parts of the higher hardness range (50 to 60 Rockwell C). Should there be doubt as to the existence of high stress and strain in any tool, it is recommended that the tool or part be normalized or stress relieved prior to plating. In the case of heat checks, it is necessary to grind the tool or part below the checked surface of the base metal to a point where a true and unchecked base metal surface is reached.

### 3. Improperly Cleaned Surfaces

A. Care should be taken to eliminate the possibilities of oil or grease coming into contact with the base metal surface to be plated. Avoid excessive handling of the tool or part.



B. Plating operation should be located in plant areas relatively free from oily or corrosive atmospheres. Parts must always be clean and free of oil, dirt and grease before plating.

C. Tools and parts should be plated immediately after cleaning to prevent oxidation and air impurities from contaminating the cleaned work surface. See "Cleaning Instructions Prior to Plating"

#### **4. Defective Surfaces**

**A. Oxides** - Ferrous metals such as industrial steels and cast iron are subject to oxidization as a result of heat treating, grinding or other surface treatments. Manufacturers of some cutting tools and parts purposely apply commercial oxides for the purpose of protection, appearance and color.

All of these oxides must be removed prior to plating either by mechanical or alkaline chemical cleaning. In the case of the manufacturer of cutting tools it is possible to obtain tools without this surface oxide applied, the natural steel finish being more applicable to plating procedure.

After the removal of oxides the recommended plating procedure should be followed, see GENERAL HARD CHROME PLATING INSTRUCTIONS (p 92).

**B. Carbonization** - Carbonization occurs as a result of chemical and/or electrical action in which the carbon in high carbon steels particularly, is attracted or drawn to the surface of the base metal. This can be recognized by a mottled or gray-black surface smudge.

Immersion of the part in certain acids or excessive reverse current (stripping) in plating solutions are the prime reasons for the formation of this surface smudge. In the CASWELL Chrome bath a ten second reverse current (or strip) is recommended to eliminate this plating hazard.

In cases where this condition is apparent the smudge must be removed by mechanical means (see "Cleaning Instructions Prior to Plating")

#### **5. Hydrogen Impregnation - Hydrogen Embrittlement**

**A. Hydrogen Impregnation** - Hydrogen impregnation is a term used to designate the presence of hydrogen gas, which has penetrated into the porous structure of the base metal or part.

Prior to plating hydrogen impregnation occurs only as a result of acid pickling or cleaning of the base metal tool or part. Penetration of the base metal by this gas is a direct cause of hydrogen embrittlement brought about by the sealing or locking in of the hydrogen gas by various surface finishes. Embrittlement rarely occurs in un-pickled or unplated tools or parts.

**B. Hydrogen Embrittlement** - Deposited CASWELL Chrome plate has the tendency to lock in or seal hydrogen gas in the grain structure of the tool or part. In all cases, it is not until this seal or CASWELL Chrome plate is applied that the formerly inert gases become active - thus causing embrittlement in the grain structure of the base metal.

Due to this action, fractures may be created either, in the base metal, and/or the CASWELL Chrome itself. The chance for hydrogen embrittlement of the base metal part or tool will increase with the deposition of heavy deposits of CASWELL Chrome plate since the greater thickness provides a tighter seal and a lesser chance for the gas to escape. This is a problem long associated with conventional Chrome plating processes.

The possibility of CASWELL Hard Chrome plate producing hydrogen embrittlement is remote. To date no evidence of hydrogen embrittlement has been found in CASWELL Chrome plated tools or parts as a direct result of the CASWELL Chrome process.

Should the unplated part or tool be hydrogen impregnated, because of acid pickling or cleaning methods, this hydrogen should be removed or driven from the base metal before plating. This is accomplished by baking the tool or part for

approximately one hour at 350 degrees F. prior to plating. After baking the recommended CASWELL Chrome cleaning and plating instructions should be followed. If this precaution is not observed hydrogen embrittlement may occur.

## **6. Failure to Follow Recommended Plating Procedures.**

Many faulty plating jobs are simply caused by failure to follow the recommended plating procedures for CASWELL Chrome plate. Due to the characteristics of the Chrome solution, it is imperative that the CASWELL Chrome plating procedure be followed explicitly. Refer to "GENERAL HARD CHROME PLATING INSTRUCTIONS (p 92)"

### **CASWELL Chrome Plate Is No 'Cure-All'**

Cutting tools that are chipped, heat checked or worn well below useful tolerance or otherwise damaged in general, cannot be restored by the application of light, or even heavy, Chrome deposits. In the case of wear parts, CASWELL Chrome plate is often applicable for salvage purposes, but the surface preparation of the base metal should equal the surface finish found on new tools or parts. After sufficient surface preparation, deposits of chrome plate can then be applied. Disregard for this precaution, however, will only nullify or lower the effectiveness of CASWELL Chrome plate.

### **Heavy versus Light Deposits of CASWELL Chrome Plate**

In all cases, the lighter deposits (.0001 to .0005 in.) of CASWELL Chrome plate are recommended on cutting tools. The reason being Chrome plate, in its lighter deposit, reflects all the base metal characteristics; finish, hardness and contour and so retains all the toughness and resiliency of the base metal. As a further contribution to the efficiency of the tool or part CASWELL Chrome plate reduces friction, has high heat resistance and reduces galling and seizure tendencies.

Conversely, cutting tools with heavy deposits of CASWELL Chrome plate as well as conventional chrome plating (.002 in. or more) operate under reduced efficiency and hazards of chipping. The base metal characteristics are lost with the heavy deposits and the working surfaces of the tool takes on the undesirable characteristics of chrome itself in its coarse and brittle state. In all cases, including wear parts, the lighter deposit is more to be desired.

Another reason for the objection to heavy deposits of CASWELL Chrome in cutting tool applications is the necessity for regrinding the tools to size after plating. Besides being a costly and time consuming operation, it has been established that ground chrome plated surfaces lose a large percentage of their wear resistant qualities brought about by the regrinding of the tool.

Where tool and wear parts are not subject to extreme pressures, shock and impact, heavy deposits of Chrome plate are applicable. Applications of heavy chrome deposits however should be limited to salvage applications as in the case of plug gages, pistons, shafts and bearing surfaces.

The problems associated with heavy deposit plating are numerous and special care should be exercised in all heavy plating applications. Most common are the following:

1. Excessive build-up on sharp corners and inverted angles
2. Treeing
3. Peeling, cracking and chipping
4. Poor adhesion.

## THE PRINCIPLES OF CASWELL Hard Chrome PLATING

### The Theory

Each square inch of anode surface area, is the source of a given number of "lines of action" which are responsible for the deposition of CASWELL Hard Chrome plate on the surface of the tool or part to be plated. The "lines of action" can be assumed to travel in a straight line (shown here) from the anode surface to the work surface or cathode.

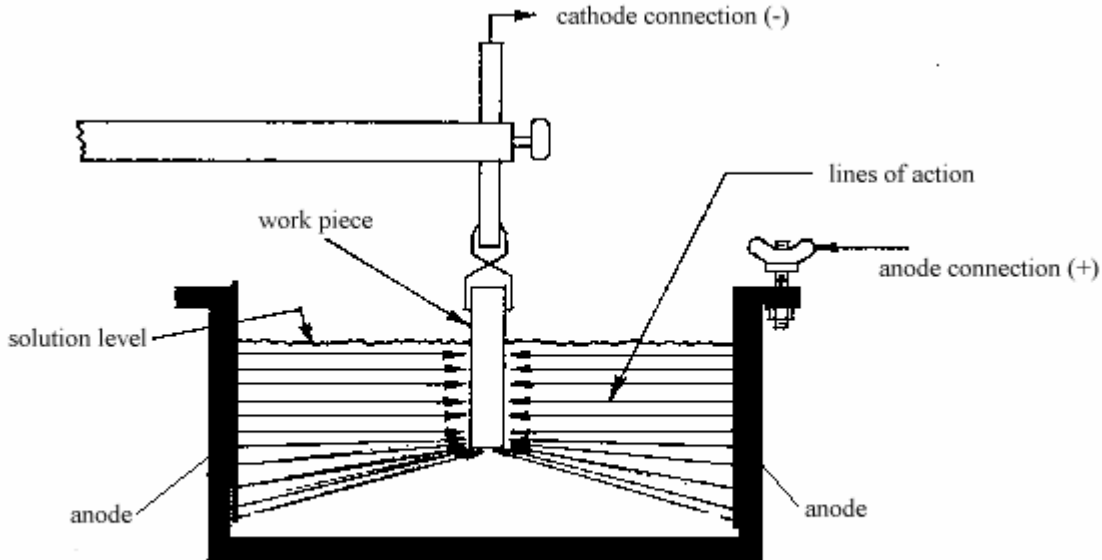

fig 7

Direction and control of the "lines of action" is necessary to the success of the plating job, as to the uniformity of deposition and the elimination of excessive build-ups. Without this control, the uncontrolled "lines of action" overlap the parallel "lines of action" thereby producing undesirable buildups as shown here.

Directional control of these "lines of action" is actually obtained by the elimination of those not needed to accomplish the plating job. This elimination is achieved by insulating the surface areas of the work from certain portions of the tank or anode surface with nonconductive and acid resistant materials as in the case of the liquid level adjuster.

Thickness of deposit is controlled by time of immersion in the plating bath at a recommended current density rate with the solution at ambient room temperature. The recommended plating current (amperage) is determined by approximating the square inch surface of the work area where plate is desired and allowing 2 amperes for each square inch of work area to be plated. See Rate of Deposition

## The Liquid Level Adjuster

In order to maintain close tolerances and avoid excessive build up of CASWELL Hard Chrome plate on certain points or work areas of the piece, directional control of the "lines of action" is required. Notice in Fig 7 (above) that the parallel (horizontal) and non-parallel "lines of action" concentrate at the lower portion of the work. This results in excessive buildup of CASWELL Hard Chrome plate at the lower end of the work as shown in Figure 8 below

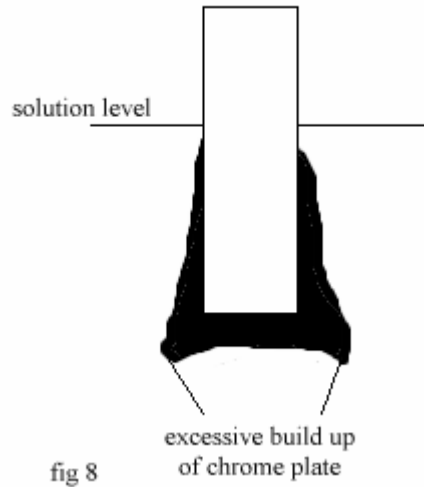

A simple and convenient method of alleviating this condition is by the use of a device known as the Liquid Level Adjuster. A typical design is shown here. The entire device is made from Plexiglass.

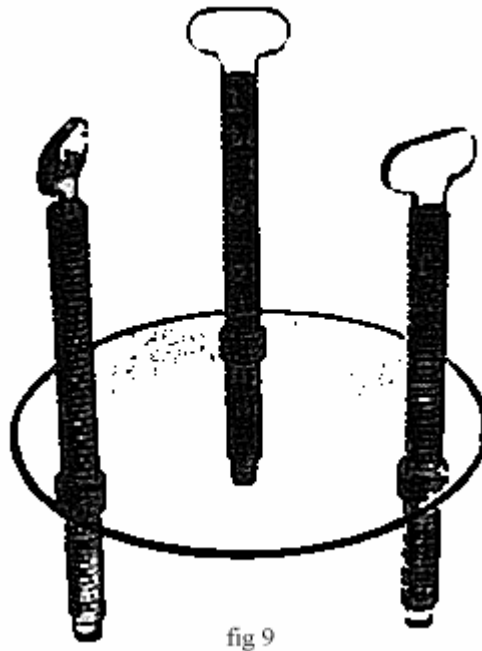

The platform of the adjuster may be raised or lowered by means of turning the threaded plastic rods. Notice in Figure 10, that the liquid level adjuster platform has been located in correct position for this particular application. In most cases, the work piece should rest on the adjuster platform while plating.

Accordingly, the liquid level adjuster platform eliminates the undesirable (or non-parallel) "Lines of Action" without which, this directional control would produce the undesirable effects of uneven deposit and excessive build-up as shown in Figure 8.

However, by the correct positioning of the liquid level adjuster platform (see Figure 10), the desired result is obtained as illustrated in Figure 11

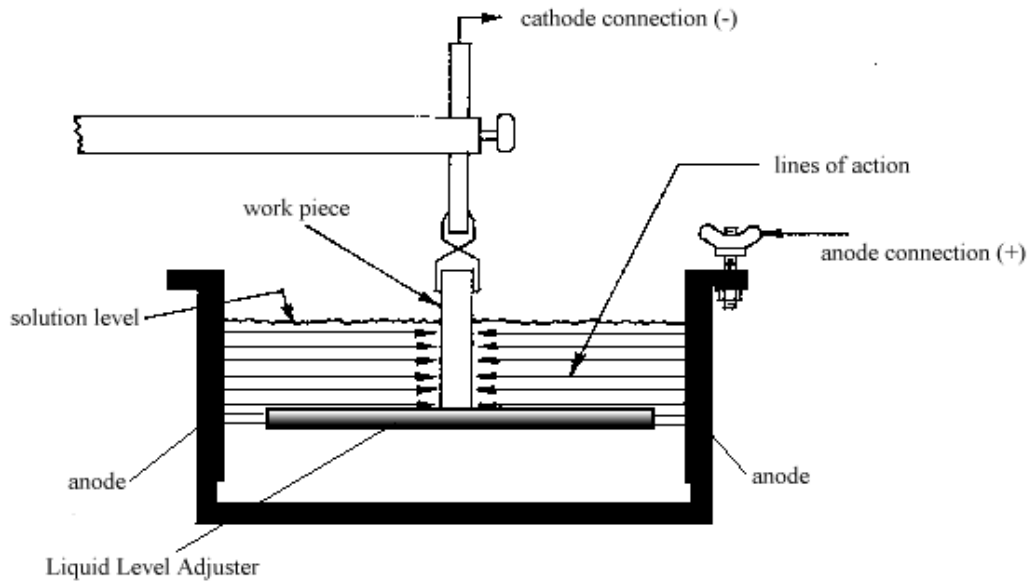
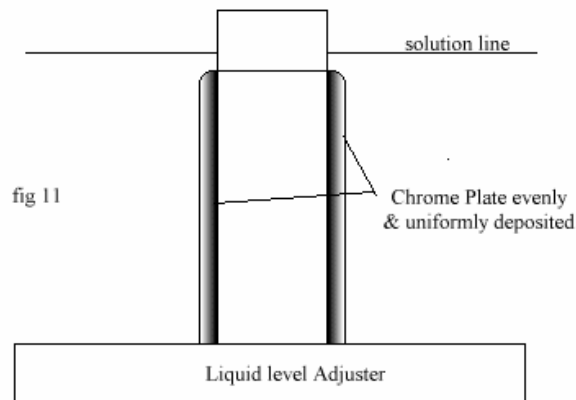

fig 10

.Parts and tools may be plated (individually) by this method to accurate dimensional tolerance. For multiple quantity plating of tools or parts to a critical dimensional tolerance. see under "Multiple Plating of Tools or Parts".



## PREPARING CASWELL HARD CHROME SOLUTION

### Preparation of Solution

To make approx  $\frac{3}{4}$  gal of CASWELL Hard Chrome Solution:

Add 5.5 US Pints (16 fl oz) of DISTILLED WATER to the tank.

Add 1 can of CASWELL Chrome Crystals to the water. (1kg)

Add 30 milliliters (1 fl oz. or approx 3 teaspoons) of BATTERY ACID



*To make up larger quantities, multiply the figure accordingly.*

*Therefore a 4 gallon setup would need 22 pints (4 x 5.5) DISTILLED WATER.*

*4 cans of CASWELL Chrome Crystals (4 x 1kg)*

*120 milliliters (4 fl oz or 12 teaspoons) of BATTERY ACID*

**Evaporation.** Water loss by evaporation takes place in the mixed Caswell Hard Chrome solution as a result of contact with the atmosphere. It is recommended that solution level be checked daily and the necessary amount of water added each day to maintain the original level. Daily evaporation loss is small, but may be minimized by keeping the plating tank covered when not in use. To avoid damage to glass heaters, only raise the level when they are cold.

**Contamination.** Caswell Hard Chrome solution is designed to minimize the effects of contamination. Non-ferrous metals such as brass, bronze, copper and zinc., etc., if allowed to remain in the solution for long periods of time, either being stripped, or not electrically connected may cause contamination of the Caswell Hard Chrome, thereby reducing the efficiency of the solution or shortening its effective life. **DO NOT STRIP NON-FERROUS METALS** (Brass, copper, bronze, etc.) in Caswell Hard Chrome Solution.

See procedure for cleaning and plating non-ferrous metals.

Your Caswell Chrome setup should be located where atmosphere is free of heavy dust or oil mist. If the solution is covered with an oil film, the oil will tend to cling to the tool or part when. It is immersed into the solution and cause plating failures.

**Temperature** Caswell Hard Chrome solution is designed for operation at room temperature (65-90F). In cases where the room temperature drops, lowering the temperature of the Caswell Hard Chrome solution to below 65F, the solution must be brought up to plating temperature before use. For optimum results, set your tank heater thermostats to approx 80 F

In some cases of production plating where long and continuous plating operations are necessary (8 hours or more continuously), the temperature of the solution may exceed 90F, particularly when plating at maximum capacity. When the

solution temperature exceeds 90F, the characteristics of the bath change with respect to rate of deposit and chrome properties. This can be overcome by enlarging the plating tank and supplying more volume of Chrome solution.

**Exhaust Requirements** All Chrome plating units should be operated in well-ventilated rooms. Chromic Acid fumes are toxic. However, with the inclusion of the MIST SUPPRESSANT, you should experience NO fumes or mist when operating this system.

To periodically check for emission of fumes, hold a flat sheet of white paper about 6" above the tank for about one minute of a plating run. If the sheet is stained brown, you should shut the operation down, until you obtain more MIST SUPPRESSANT from CASWELL Inc.

### Depletion of Solution

Caswell Hard Chrome solution does not require adjusting or balancing throughout its entire plating life.

CHEMICALS, OR OTHER INGREDIENTS, SHOULD NEVER BE ADDED TO CHROME in an attempt to increase the effective life or operating efficiency of the solution. Additives may greatly decrease the life and operating efficiency of the solution.

Normally, the depletion of the Caswell Hard Chrome plating solution can be recognized when a dense chrome deposit is no longer obtained and a powdery non-adherent deposit is obtained instead. When this happens, a new charge of Caswell Hard Chrome solution should be utilized. The exhausted solution should be discarded and the tank replenished with a fresh charge of Caswell Hard Chrome solution. .

### Siphoning of Caswell Hard Chrome Solution

When the plating solution is depleted, it can readily be removed from the plating tank by siphoning as shown below. Flexible acid resistant plastic tubing should be used for the hose connections to the glass loop and T-shaped glass tube as well as the rubber bulb. Repeated compression of the rubber bulb starts the siphoning cycle. After emptying the tank, the rubber bulb should be washed thoroughly in water to remove the excess solution and thus prevent the bulb from deteriorating.

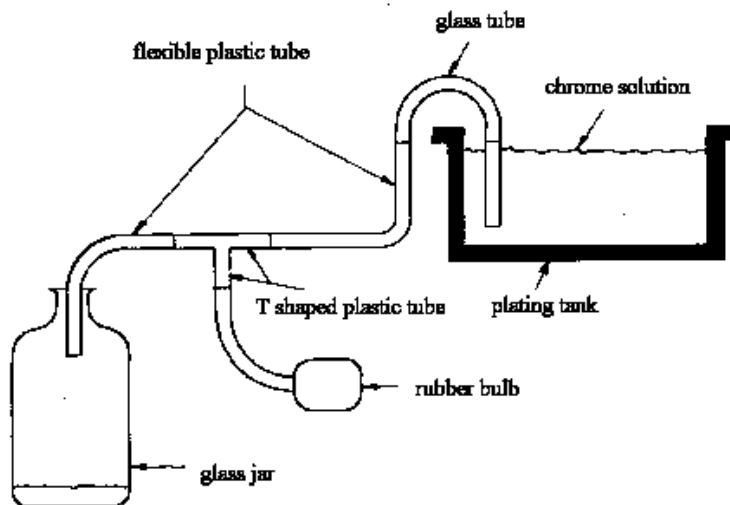
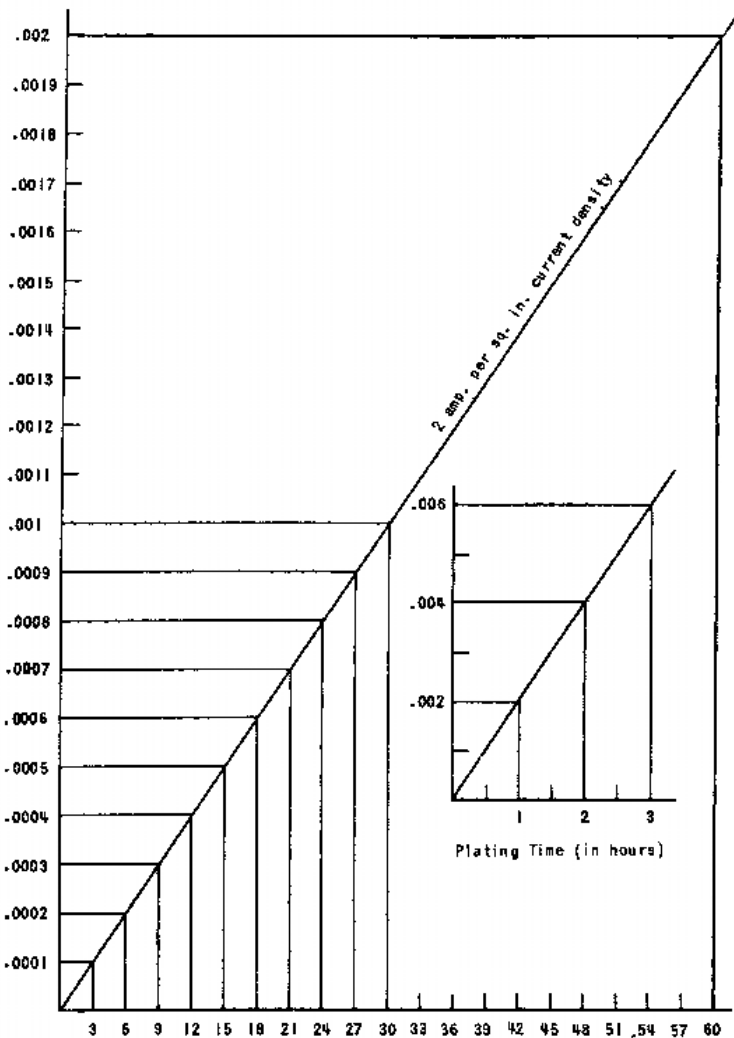

fig 6

## RATE OF DEPOSITION CHART



Rate of Deposition Chart

Values given are based on the recommended current density of 2 amps per sq. in.  
Solution temp 80 deg f

fig 3

The Rate of Deposition Chart illustrates the thickness of Chrome plate deposited on the surface of the base metal in any given time, based on the recommended current density of 2 amps. per sq. in. For example, should you want to increase the diameter of a plug gage by 0.001", approximately 15 minutes plating time at the standard current density of 2 amps. per sq. in. would be necessary in order to deposit .0005" on the surface of the plug gage.

In the GENERAL HARD CHROME PLATING INSTRUCTIONS, notice that an initial plating action (after stripping) is based on a current density of 1 amp. per sq. in., and that the instructions call for this lower current density to be maintained for 1 minute, after which the current density is then increased to the higher rate of 2 amps. per sq. in.

### IMPORTANT -

ALL TIMING CALCULATIONS REFERRED TO IN THE RATE OF DEPOSITION CHART ARE BASED ON THE 2 AMP PER SQ.IN.

CURRENT DENSITY AND TIMING REQUIRED FOR THE DESIRED DEPOSIT THICKNESS SHOULD START WHEN THE 2 AMP.PER SQ.IN.CURRENT DENSITY STARTS.

### Current Densities

Current density is defined as the amperage (current) applied to one sq. in. of surface to be plated with your setup.

Tools and parts are always plated at the current density of 2 amps. per sq. in. As an example of how to arrive at the proper ammeter reading for tools or parts to be plated, assume a cutting tool with 5 square inches of surface to be plated. During plating, the ammeter would be set to read 10 amps. (After the initial stripping and plating procedure has been followed) the ammeter reading would remain at 10 amps until the desired deposit thickness is attained.



## USE OF CONFORMING ANODES

Since each plating job represents a slightly different problem, and because of the many applications for Caswell Hard Chrome plate, no one case example can be given that will cover all plating applications. The recommended procedure for a shallow recess die for example, might be entirely different from that of a deep recessed die. For this reason the subsequent paragraphs will describe the fixtures or setups and the use of conforming anodes for several different applications as a general guide.

The plating principles of jigs or fixtures described in the following pages may be applied in the case multiple plating applications, that is, where more than one part or tool is plated at one time. See "Multiple Plating of Tools & Parts"

### Shallow Recess Dies

In the treatment of the work piece, shown in Figure 18 the die rests on a sheet of lead bent to an L-shape in order to make good electrical contact and afford simplicity in jiggling. At the bottom of the die the sheet lead is brought flush with the surface where plate is desired, in order to provide uniformity of plate and eliminate buildup of chrome on the lower edge, in effect increasing the surface area at the lower edge of the die. The top surface of the die is also shielded with sheet lead (flush with the face) for the same reason.

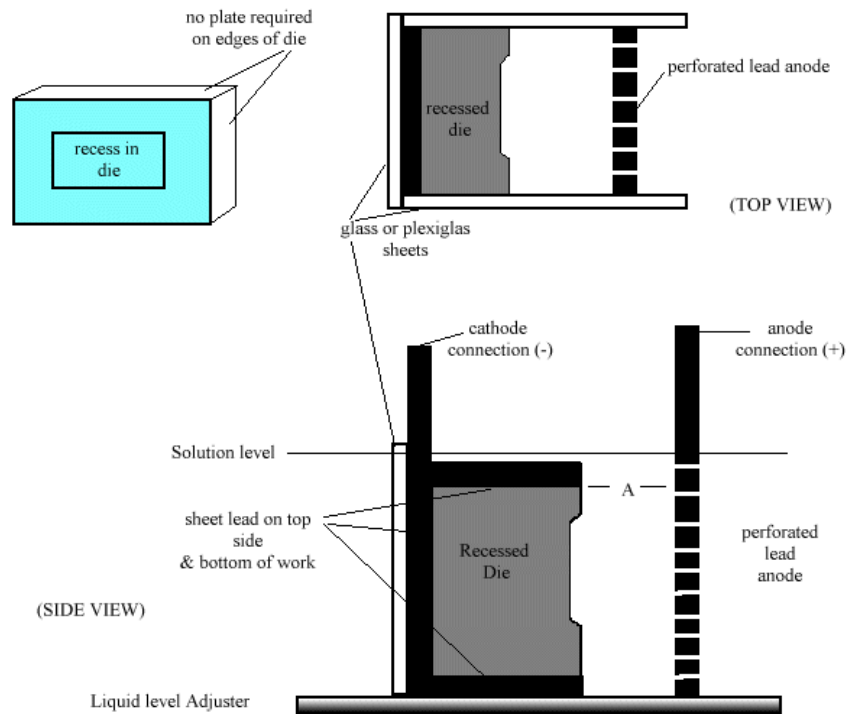

fig 18

Chromic acid resistant plastic sheets encase the rear and sides of the die to control ionization of the "lines of action". Note that the plastic sheets extend from the face of the die to the sheet lead anode or flat plating tank side, affording better "line of action" control. "A" distance of anode to work surface may be 2 to 4 inches in most cases.

The assembled jig or fixture rests on the Liquid Level Adjuster Platform and the platform is lowered into the Caswell Hard Chrome solution to a point where the solution level is 1/8th inch above the work piece.

Direct connection is made to the conforming anode from the power source.

Work should be cleaned thoroughly prior to plating as outlined "Cleaning Instructions Prior to Plating" and plated following the GENERAL HARD CHROME PLATING INSTRUCTIONS.

In Figure 19, again the application is a shallow recessed die, but a case where gases may become trapped because of the change in the work surface contour of the die. Note the sharp corners or inverted angles present in this application: necessitating the different arrangement and positioning of this die in direct contrast to the one shown in Figure 18. Where sharp corners or inverted angles are involved in any plating application, the possibility of entrapped gases exists. See section on "Trapped Gases"

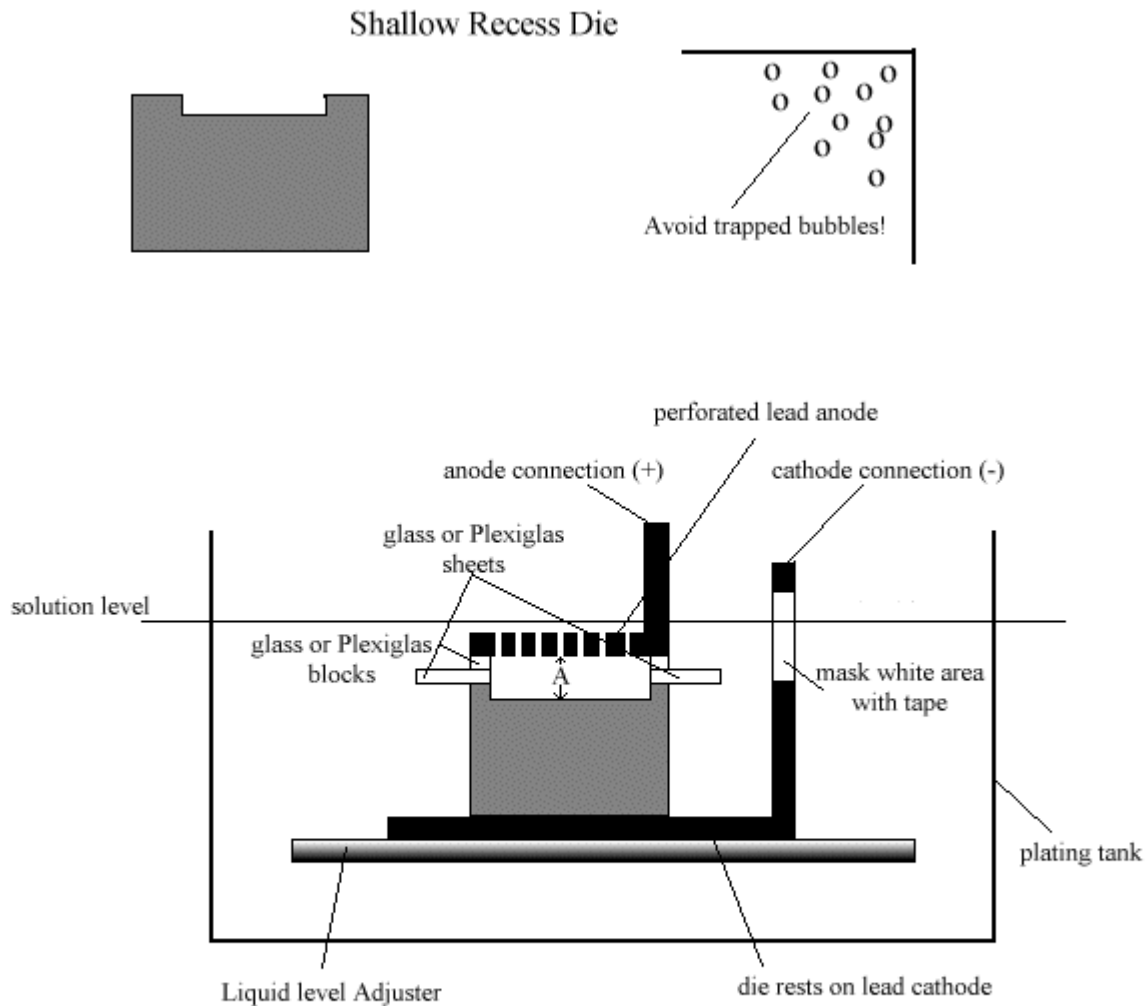

fig 19

The die in this case rests on its back with the surface to be plated facing upward thus allowing the gases formed to escape freely. Note that the conforming anode is perforated to further allow the escape of generated gases.

"A" distance of anode from cathode may be 1" in the case of small dies and 2", in the case of larger dies. Glass or acid resistant plastic blocks are used to control this distance.

The jig or fixture used in Figure 16 is again different from the previous illustration. The cathode is again a sheet of lead (on which the work rests), L-shaped to provide good electrical contact. Note that a portion of the vertical extension of the lead cathode is masked or insulated with acid resistant tape so as not to attract "lines of action" to that portion of the cathode opposite the anode.

Glass or sheets are used in this application to further control the "lines of action". In the case of a small die or work piece, Figure 16, the plastic sheet should extend approximately 4 inches beyond the edge of the work piece. On larger work or dies, the plastic sheet should extend to the walls of the plating tank, completely insulating the work piece from current action below the level of the plastic sheets.

The fixture or jig is assembled on the Liquid Level Adjuster Platform and lowered into the solution so that the solution just covers the perforated lead, conforming anode. Direct connection between power source and perforated lead anode is made. Cathode is similarly connected with cathode terminal. General cleaning and plating instructions apply.

### Deep Recess Dies

A conforming anode is used in deep recessed die applications also. As shown in Figure 20, the perforated conforming anode should follow the contour of the surface to be plated and in most cases be equidistant from the work surface. "A" distance can be 1 to 2 inches in most deep recess applications.

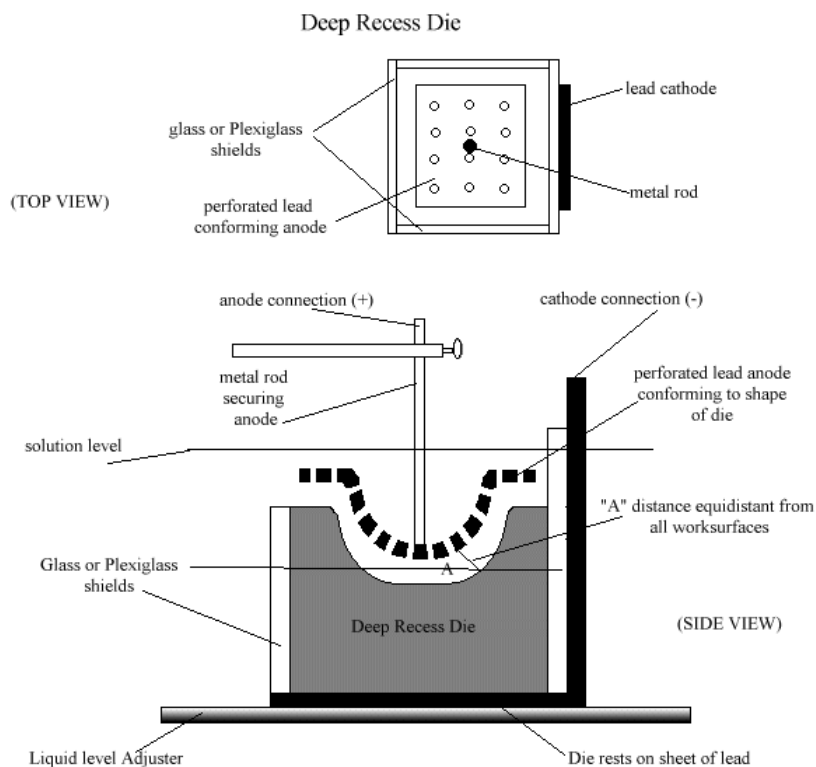

fig 20

The conforming anode in this example is required to properly distribute the "lines of action" in the deep recess of the work, eliminating the chances for un-plated areas and promote uniformity in thickness of deposit. Note that this work piece is positioned in the plating tank with the surface to be plated facing upward (perforated anode is used), thus reducing the hazard of entrapped gases. See "Trapped Gases"

The fixture in Figure 20 is, in effect, a plastic box which is open at both ends and resting on a piece of sheet lead U-shaped so that the die rests on the horizontal portion of the sheet lead U serving as the cathode connection. In this way the work

piece makes contact by pressure of the die weight alone. The lead cathode is connected directly with the cathode terminal on the power source.

The perforated conforming anode, in Figure 20, rests on plastic blocks controlling the "A" distance of the anode from the cathode. The anode in this case, may be held in position by the use of acid resistant tape or clamps. The anode is perforated to affect the release of generated gases rising from the work piece and is connected directly to the anode terminal on the power source.

This jig or fixture for ease in handling can be assembled on a bench before being lowered into the Caswell Hard Chrome solution. The jig should rest on the Liquid Level Adjuster Platform and the solution level (as illustrated) may be 1/8th inch above the work surface. This method will produce a feathered edge around the outer edge of the surface being plated.

Note in the illustrations, the conforming anode is a greater distance from the work surface opposite the outer edge of the die to produce a featheredge. Should positive uniformity of deposit on all surfaces of the die be required (eliminating the feather edge), the anode should be equidistant from the work surface at all points and the solution level raised to cover the conforming area of the anode.

General cleaning and plating instructions apply.

## CLEANING INSTRUCTIONS PRIOR TO PLATING

Surfaces to be plated must be clean and free from rust and scale.

To clean work prior to plating, the following general procedure will be sufficient in most cases:

1. Degrease work surface thoroughly using a commercial vapor degreaser, acetone or lacquer thinner.
2. Scour all the surfaces with 'Soft Scrub Household Abrasive Cleaner' or Vim or Comet.
3. Rinse work thoroughly in clean water and plate immediately.

**DO THE WATER BREAK TEST.** Continuous water films are a good indication of properly cleaned surfaces. Immerse work in water and look for an even distribution of water film on the surface to be plated. Droplets or surfaces where water will not adhere will indicate an oily surface not suitable for plating.

Commercial oxides and those resulting from nitriding of tools or parts and/or other stubborn surface impurities can be most effectively removed by immersion in a solution of 25% (by vol.) muriatic acid for 15 minutes followed by a cold water rinse before plating.

Another recommended means of removing stubborn surface impurities is by use of a liquid hone (wet blast or vapor blast). Various grit sizes are used to obtain the desired finish; 100, 400 and 1200 grit are recommended for rough, medium and fine finishes, respectively. CAUTION: Care must be taken not to destroy cutting edges or fine base metal finishes by too prolonged or severe treatment. A cold water rinse should follow before plating.

Extremely fine base metal finishes found on mold cavities, draw dies, etc. requires that special cleaning procedures be followed so as not to damage the mirror-like finish. Stripping or severe etching procedures are not recommended.

In most cases these surfaces are free from stubborn surface impurities and require simply degreasing followed by immersion in SP Degreaser.

Afterwards the surface should be given a cold-water rinse.

### **Protecting Cleaned Surfaces**

If for any reason, the already cleaned work surface cannot be plated immediately after cleaning, immersion in SP Degreaser will prevent oxidation of the cleaned surface. The work can then remain in the atmosphere up to periods of an hour or less. When ready for plating, parts should be rinsed in clean water and plated.

## PLATING MILLING CUTTERS FLAT PLATES & DRILLS

PLATING DRILLS & TAPS. Figure 12 shows the arrangement for plating a single drill or tap. After cleaning, the drill or tap should be located in the approximate center of the tank and immersed in the solution to cover the surface to be plated.

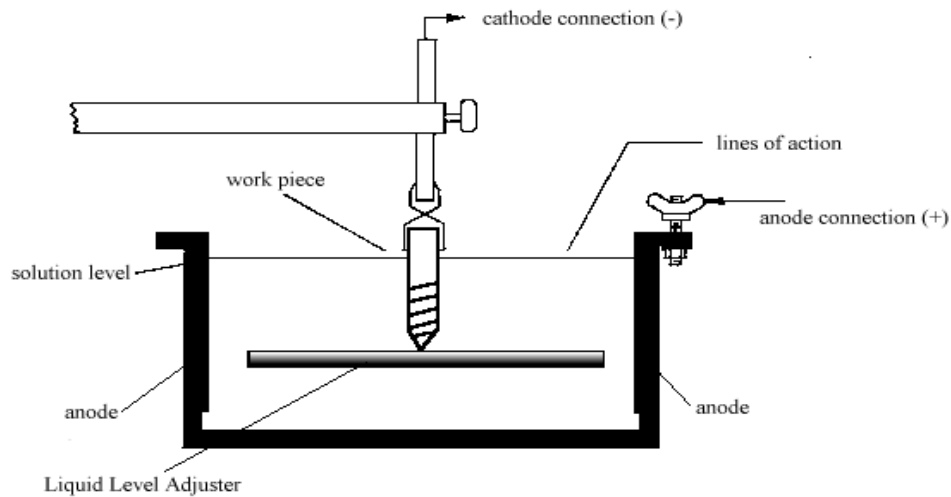
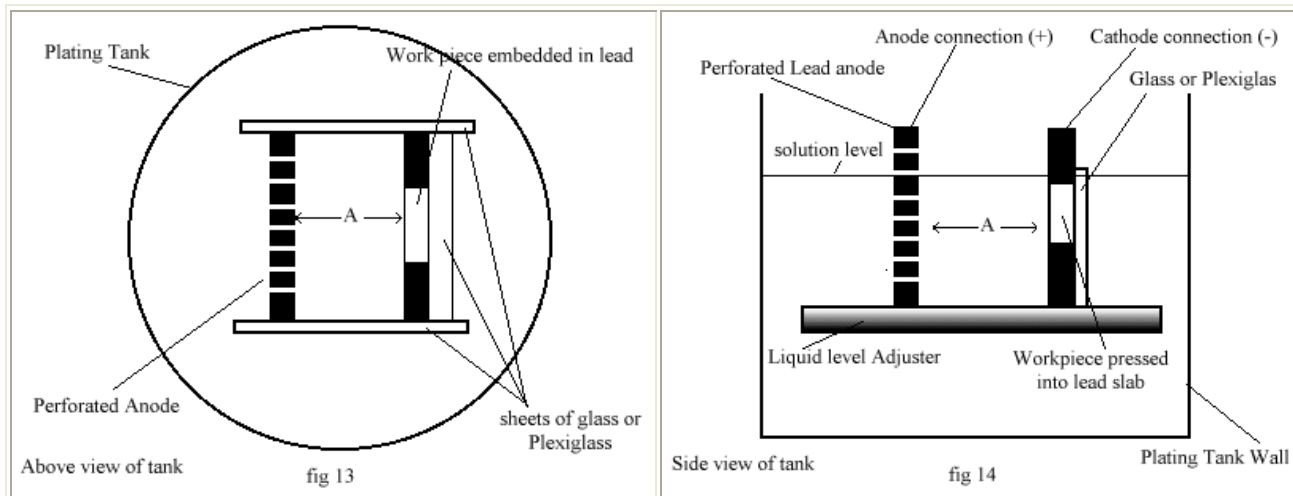

fig 12

Next, the liquid level adjuster platform should be positioned so that it just touches the point of the drill or tap. Then the GENERAL HARD CHROME PLATING INSTRUCTIONS should be followed. PLATING FLAT PLATES. When plating thin flat plates such as small dies or parts, the set-up illustrated in Figures 13 & 14 are recommended. In this application, the sheet lead cathode is cut out and the piece to be plated is pressed tightly into the sheet of lead.



Sheets of glass or acid resistant plastic form a fixture for positioning the lead sheets and for controlling the "lines of action". To allow circulation of solution the sheet lead anode should be perforated with holes. The "A" distance from anode to cathode should be a minimum of two inches. On larger work areas requiring higher plating amperage, the "A" distance should be increased to approximately four inches. When determining the area and plating amperage, the area of the piece plus the lead cathode surface facing the anode should be calculated rather than the area of the piece alone.

## PLATING MILLING CUTTERS

The recommended method for plating milling cutters is shown in Figures 15 & 16.

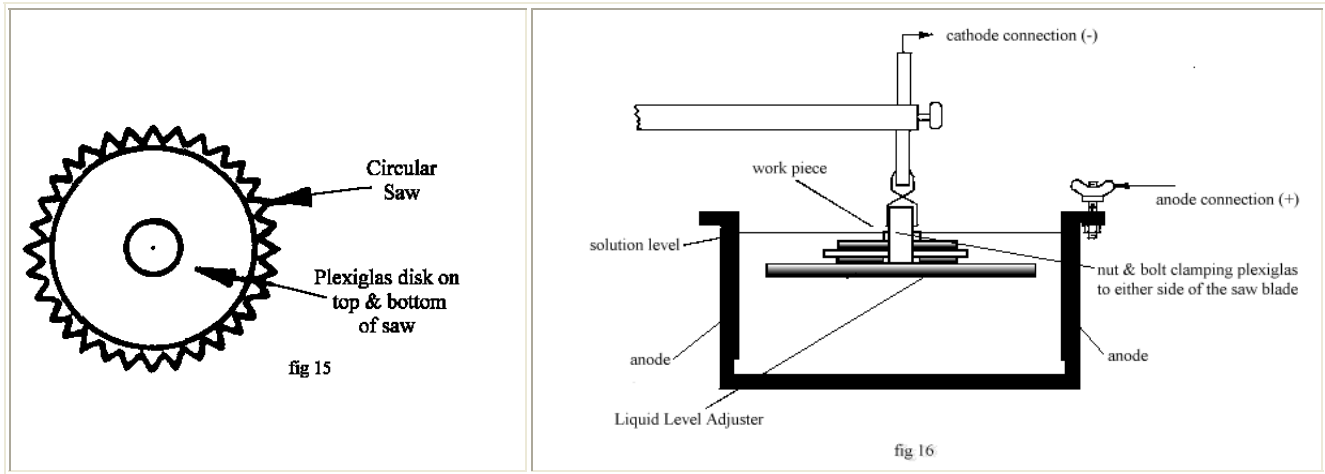

Thin glass or acid resistant plastic discs are placed on top and bottom of the cutter in the approximate center of the plating tank. Solution level should be 1/8" from the top surface of the teeth.

Excessive plating amperage may cause the sharp teeth to become burned and may result in a non-adherent flaky deposit. To avoid this condition, the area of the surface to be plated should be determined using the following formula:

OUTSIDE DIAMETER OF CUTTER x 3.2 x THICKNESS OF TEETH, assuming the cutter O.D. measures 5" and is 1/8" thick, then the area becomes:  $5 \times 3.2 \times 1/8 = 2$  sq. in.

The plating amperage or current (based on a 2 amp. per sq. in. current density) is twice the area or 4 amperes.

## HARD CHROME PLATING MULTIPLE PARTS

(Jigs and Fixtures Anode Control)

When Caswell Hard Chrome plating two or more pieces of work simultaneously in a plating unit, some scheme must be employed for:

1. Controlling the "lines of action" properly to obtain uniform deposit.
2. Securing and holding work pieces in their correct position relative to each other and the plating tank or anode.
3. Making good electrical contact between cathode fixture or jig and each piece to undergo plating.

In multiple plating as in the plating of a single work piece, GENERAL HARD CHROME PLATING INSTRUCTIONS should be applied.

### General Recommendations

The following recommendations should be observed in all multiple plating operations:

**Overloading** Care should be exercised so as not to attempt to plate more square inches of surface area than that allowed by the maximum capacity of the power source. The ratio of 2 amps per square inch of TOTAL surface area must be adhered to. Inaccurate estimation of surface areas in square inches is frequently the cause of plating failures. See Ammeter settings for taps and twist drills based on pre-calculated current densities in relation to the square inch surface of various sizes. As a further guide to the calculation of surface area in square inches refer to:- Formulas for Determining Area

**Good Electrical Contact.** If good electrical contact is not made to each work piece in the multiple plating application, the parts making poor contact will not receive Caswell Hard Chrome plate at an equal rate of deposition and finish may be spotty or even remain un-plated.

**Positioning Work in Plating Tank.** In multiple plating, one of two procedures may be used depending on the degree of accuracy and uniformity of plate required.



## MULTIPLE PARTS PLATING TO NON CRITICAL DIMENSIONS

Where dimensional accuracy is not critical, the methods given in Figures 23, 24, 25, 26 & 27 may be applied.

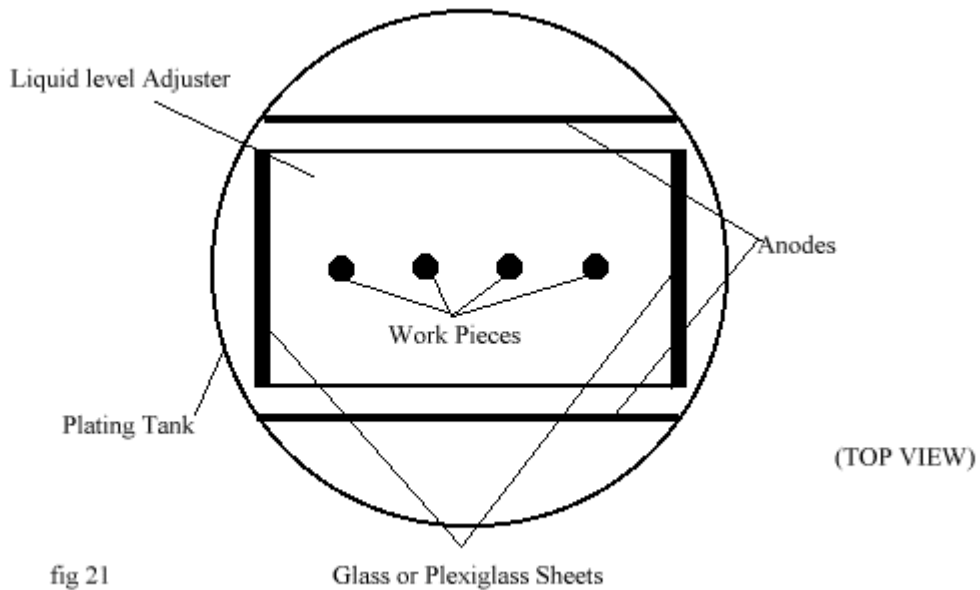

In Figures 21, 22 & 23 for example, the procedure for plating a number of twist drills or similar objects is shown positioned in a straight line. Note that the Liquid Level Adjuster Platform is positioned to control the horizontal "lines of action" and that the distance between each tool or part ("A" dimension in Figs 22 & 23) should be equidistant from each other or no closer than the maximum nearness as specified in Table 3.

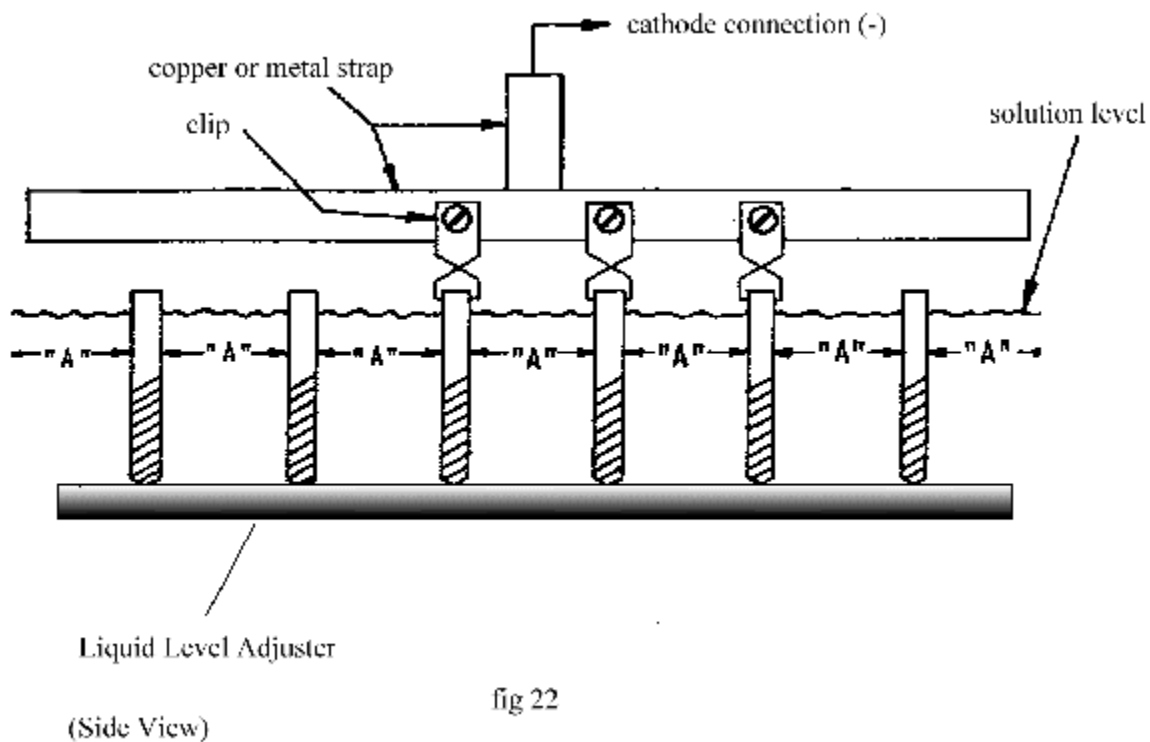

TABLE 3 Recommended Spacing for Multiple Plating.

Diameter or size of work * (in inches)	"A" Dimensions (in inches)
up to 1/4	2
3/8 to 1	4
1.25 to 2	6

\*NOTE In applications where the dimension of the work is over 2", follow procedure as outlined in Figures 21 and 22.

### Square or Rectangular Objects

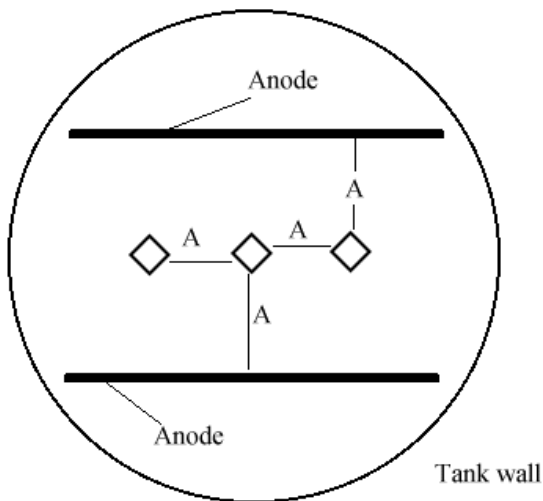

fig 23

When plating multiple objects square or rectangular in cross-section, the parts or objects should be arranged in the supporting jig or fixture so that the flat planes of the work do not face each other. See Figure 23

Figure 26 shows a simple method for racking or jiggling tubular objects in single or multiple plating applications.

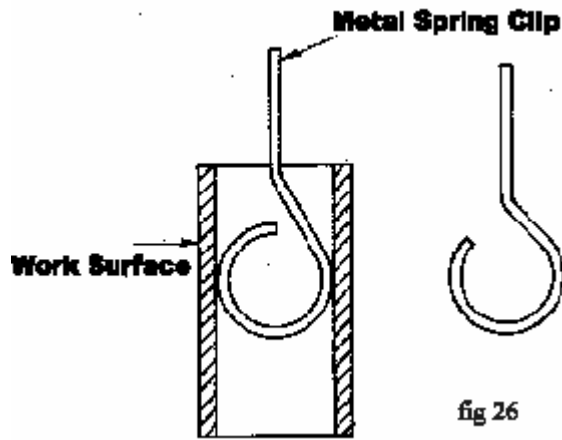

fig 26

Small Tools or Parts - (Figures 24 & 25) shows how several small tools or parts may be plated utilizing the full power capacity of the Caswell Chrome Plating unit. The sheet of lead electrically connected to the ends of the plating tank, divides the plating tank forming two plating compartments. In effect, allowing a greater number of small tools or parts to be plated at one time.

Caution, only commercial lead sheet free from antimony, tin and bismuth may be used for the dividing partition in this application. Do NOT use Caswell Chrome Anodes.

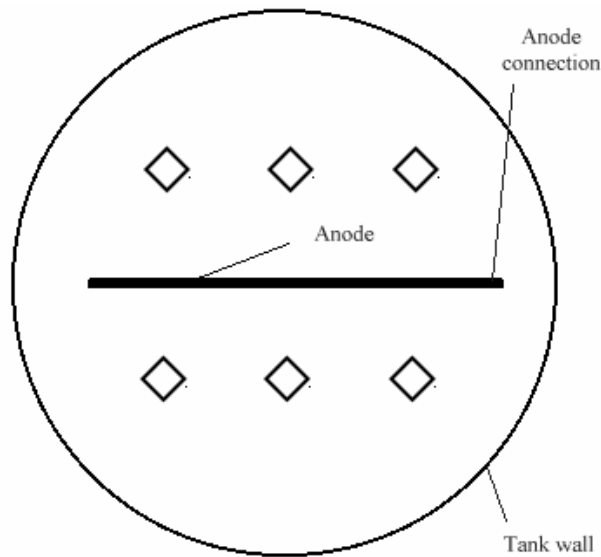

fig 24

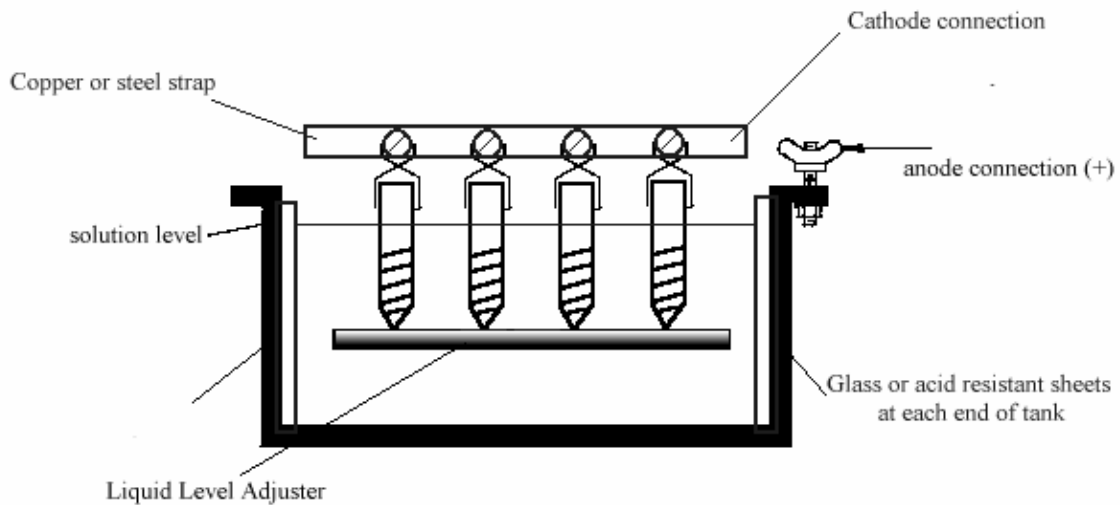

fig 25

## MULTIPLE PLATING TO CRITICAL DIMENSION TOLERANCES

As in the case of inspection gages and parts of extreme close tolerance, it is necessary to Hard Chrome plate with more exacting control when plating a number of parts at one time. Figure 21, and 22, suggests a jig or fixture for plating a number of pin type plug gages at one time where the dimensional tolerance is normally critical. The same principle will apply to other tools or parts in the same dimensional category.

To plate the assembled fixture, as shown in Fig 27, it must rest within the plating tank on the Liquid Level Adjuster Platform. The Liquid Level Adjuster is then adjusted to bring the solution level to a point 1/8" above the top of the gage as in Figure 22.

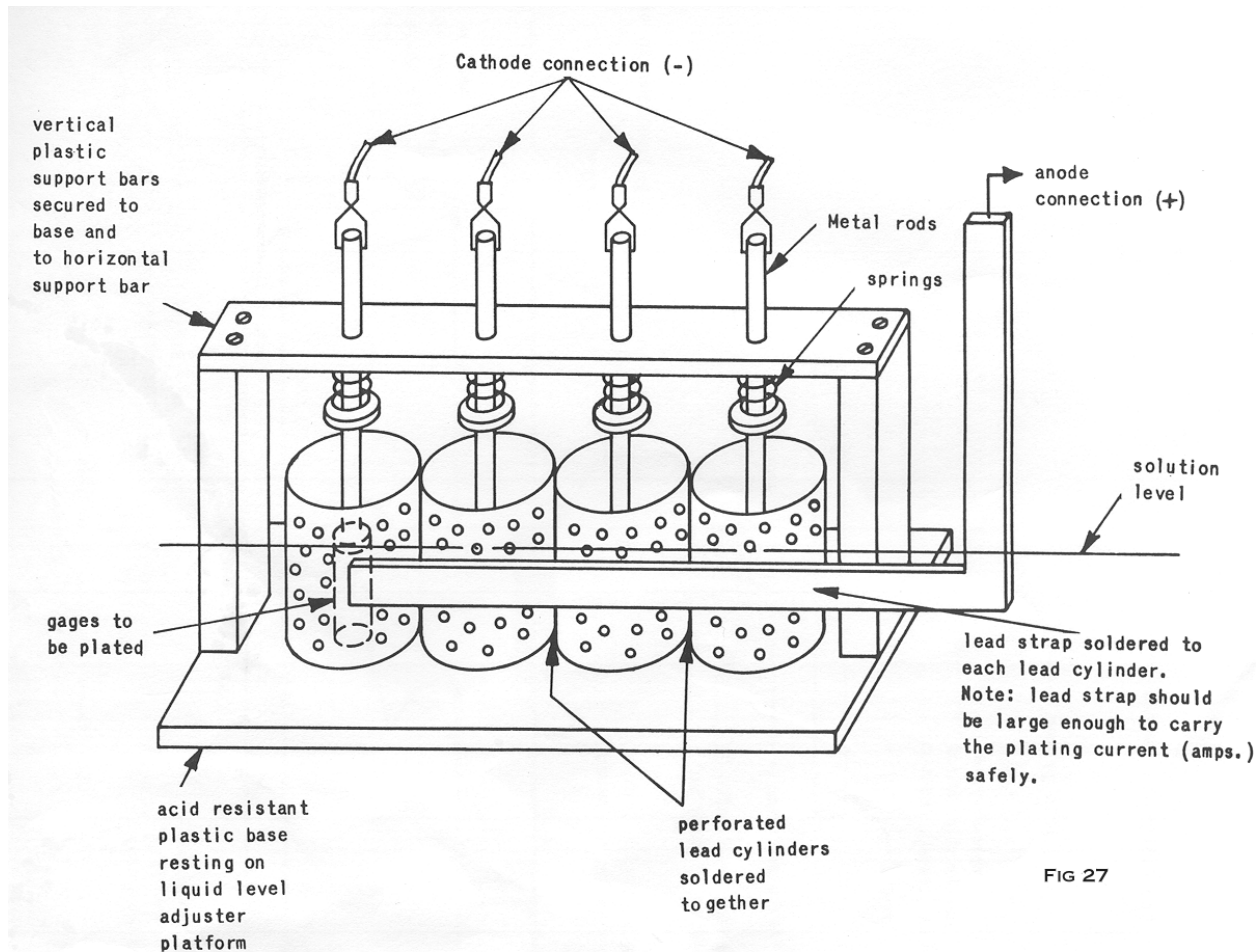

FIG 27

The gages are positioned equidistant from the inside walls of the perforated lead cylinders by means of a series of small plastic plugs. The spring held metal rod must have sufficient pressure to make good electrical contact with the lead washer and consequently the work.

NOTE: THE GENERAL HARD CHROME PLATING INSTRUCTIONS (P 92) ARE FOLLOWED IN MULTIPLE PLATING APPLICATIONS.

NOTE: See the "Rate of Deposition" chart, for determining plating time in relation to the Hard Chrome deposit required.

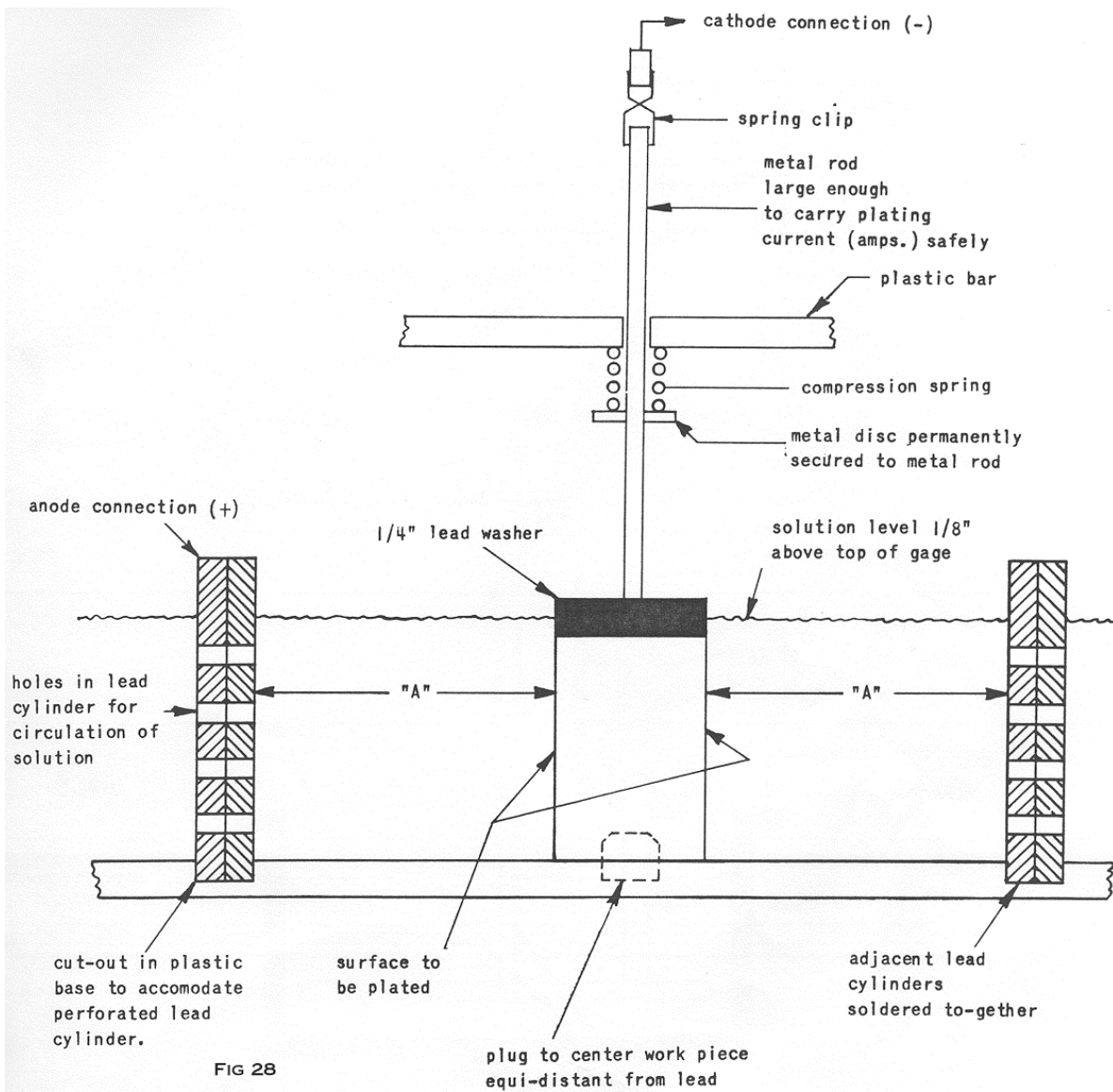

FIG 28

Fig 28. Fixture for multiple plating pin type plug gages.

See fig 27 for complete fixture.

## INSIDE DIAMETER PLATING

Satisfactory inside diameter plating depends on several factors including the type of material, shape and size of the internal anode as well as the location of the internal anode with respect to the work surface.

### Internal Anode Material

A lead rod or steel drill rod will be found most suitable for use as the internal anode in most applications involving circular shapes. Lead in the form of sheet or rod cut to the desired shape and length is also useful as an internal anode, where odd shaped surfaces must be plated, i.e., mold cavities, stamping dies, etc. It is imperative that lead be used in all applications requiring lead anodes, internal, conforming or otherwise. Steel anodes should not be used for prolonged plating operations, for more than 30 minutes continuous plating time. Copper or brass anodes should never be used.

### Shape of Internal Anode

Figure 17 shows a cross-sectional view of typical internal anodes used in plating various inside work surfaces. Where the inside surface of the tube is perfectly cylindrical, an internal anode circular in cross section as shown in Figure 17A should be used. Oval shaped work surfaces require an oval shaped anode, Figure 17B for even deposition of plating.

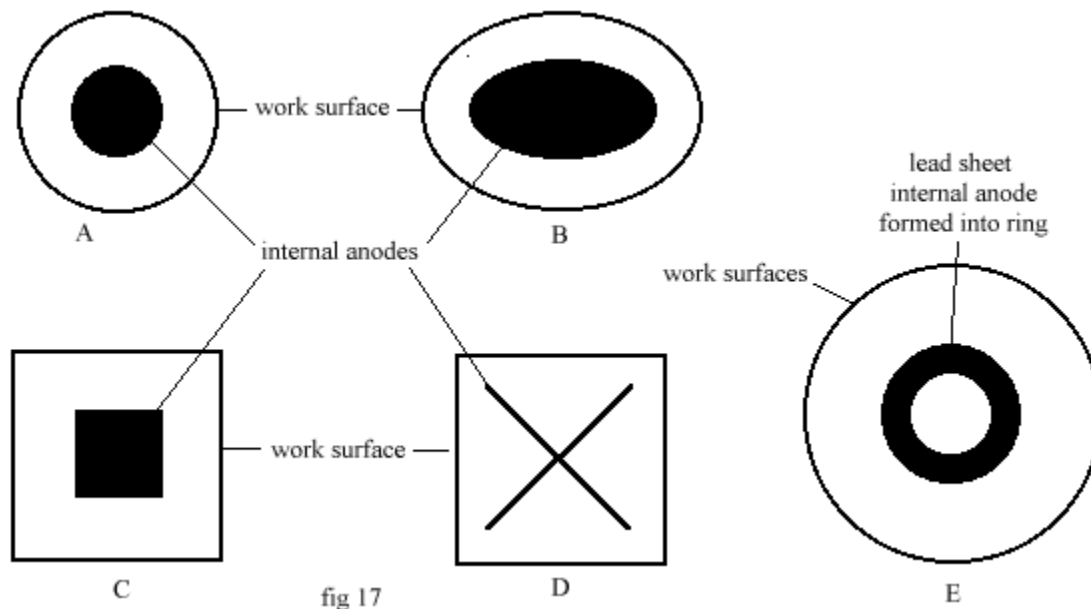

For square or rectangular inside surfaces, anodes shown in Figure 17C or 17D may be used. For dimensional build-up and close tolerance applications a square internal anode, Figure 17C, should be used. For light deposits where tolerances are unimportant the X - shaped anode, Figure 17D will be satisfactory.

When plating large internal surfaces, that is, over 7 inches in diameter, the arrangement shown in Figure 17E is recommended. For these applications, the sheet lead internal anode is formed into a ring or tube.

The lead tube should be perforated to provide adequate circulation of solution during plating.

### Size of Internal Anodes when Plating Inside Diameters

The size of internal anodes will depend on the inside diameter of the work. Internal anode should always have sufficient cross section area to handle the current flow safely. Table 2 makes recommendations for the diameter size of internal anodes in relation to the work piece I.D.:

The greater the cross-sectional area of the internal anode is, the more current it can handle. Excessive temperature rise (heating) of the internal anode or the anode leads indicates that the cross-sectional area of the anode or lead is too small.

The following table makes recommendations for sizes of internal anodes in relation to the work piece I.D.

TABLE 2 - Size of Internal Anodes for Plating Inside Diameters

Work I.D. (in inches)	Solid Rod Internal Anode O.D. (in inches)	Work I.D. (in inches)	Sheet Lead Ring Internal Anode O.D. (in inches)
1/4	1/32	7	3
1/2	1/16	8	4
3/4	1/8	9	5
1	1/8	10	6
2	1/4	11	7
3	1/2	12	8
4	3/4	13	9
5	1	14	10
6	2	15	11

CAUTION - For good contact, make sure that the anode lead is clamped securely to the internal anode.

#### Location of Internal Anode

To obtain even deposition of Hard Chrome plate on the work surface, the internal anode should be equidistant from the surface to be plated. Using a cylindrical tube as an example, if the anode is off center with respect to the tube diameter, the tube surface closest to the anode will receive a heavier deposit than the opposite surface of the tube.

Jigs made of glass, Lucite, or other acid resistant plastic, may be used for supporting the internal anode and the work in the plating solution. The internal anode should be held securely in place to prevent it from touching the work. This is sometimes accomplished by drilling a recess hole in an acid resistant plastic jig or base holding the work. If the anode does touch the work accidentally during operation, a short circuit occurs which may cause serious damage, that is, the work surface may be burned because of arcing.

#### Circulation and Level of Solution

Regardless of the length of the work, provision should be made for free-circulation of plating solution over the entire work surface. Jigs, where used, should not block the top or bottom of the work cylinder or tube. This may be accomplished by positioning the work on an acid resistant plastic fixture, which is drilled to allow free circulation of Caswell Hard Chrome solution through the plastic base. In general, the plating solution level should be about 1/8" above the top of the work surface to be plated.

**Cathode Leads** Cathode leads, like lead anodes, must have sufficient capacity to handle the current flow safely. Wire leads, as well as clips or connection clamps, that are undersize (insufficient current carrying capacity) will overheat. Suggested American Wire Gauge Sizes for 20 amp, 50 amp 250 amps are 12, 8 and 0 respectively. Smaller sizes may be used where currents are below maximum rating of the unit.

#### Constructing Jig or Fixture for Plating Inside Diameters

1. Construct jig or fixture, being careful to drill sufficient number of holes in the fixture base to allow free circulation of Caswell Hard Chrome solution over the area to be plated.
2. Clean work thoroughly as discussed under "Cleaning Instructions Prior to Plating"
3. Insert work piece in jig, being sure that the steel or lead internal anode conforms to the work surface, and is centered equidistant from all sides of the work surface area. Work should slip fit into the plastic base and be held securely in position.

Cathode clamp should be designed to permit good electrical contact, construction similar to hose clamp construction is recommended.

4. Set fixture and work piece assembly approximately in the center of the liquid level adjuster platform, and lower into Caswell Hard Chrome solution to the point where the solution level is 1/8th inch above the work surface to be plated.

5. Disconnect anode terminal link from the plating tank.

6. Connect the anode to anode-terminal (+). Be sure internal anode holds center of the I.D.

7. Connect one end of the cathode terminal lead securely to the cathode terminal (-) and the other end to the cathode clamp attached to the work piece.

8. Follow GENERAL HARD CHROME PLATING INSTRUCTIONS



## DEPOSIT LOCATION CONTROL

In some Hard Chrome plating applications certain surfaces of the tool or part must remain un-plated while in others, a "feathering" or tapering of the plate is desired. The method for accomplishing this is referred to as "Deposit Location Control". Essentially, this method utilizes sheets of glass, acid resistant plastic sheets and commercial lead in the construction of jigs and fixtures for accurately controlling chrome plate deposits.

The jigs and fixtures are always designed to apply to a specific plating application and are normally used in conjunction with a Liquid Level Adjuster. Two advantages are inherent in following the method of "Deposit Location Control":

- 1 - It permits the accurate control of deposition, both to location of the plate and the uniformity in which it is applied.
- 2 - It permits full use of the working capacity of the system.

Applications.

In the sections under "Use of Conforming Anodes", and 'Multiple Plating of Tools & Parts', several illustrations of "Deposit Location Control" are given. Other examples applicable to typical plating jobs are illustrated, Figs. 29, 30, 31 and 32

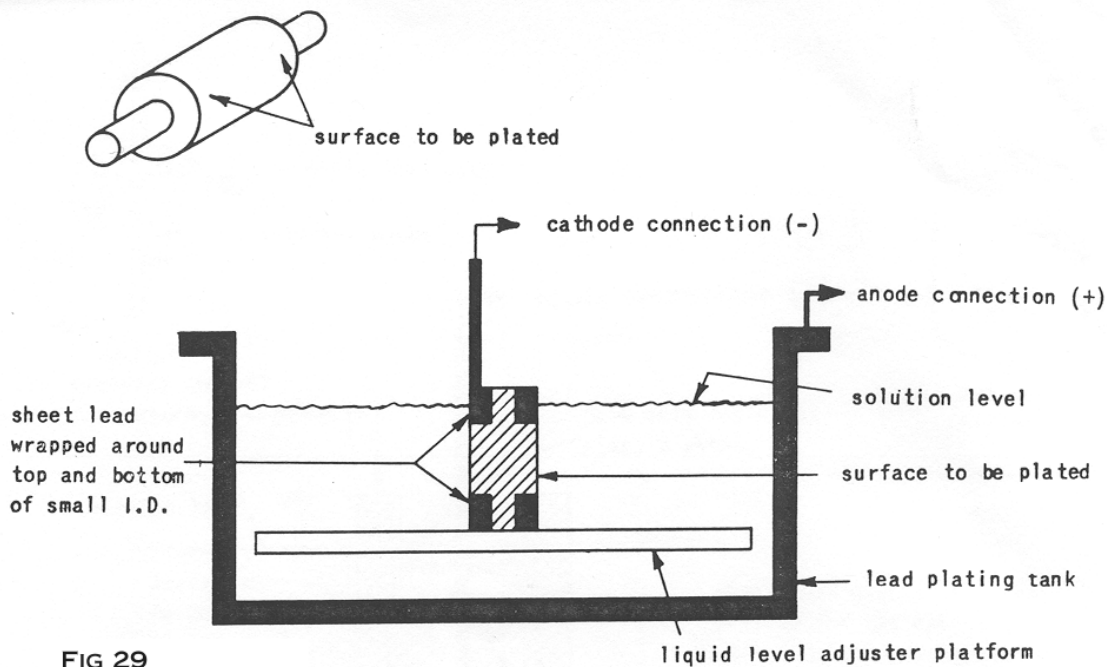

FIG 29

*Fig 29 Shows a method of Hard Chrome plating the large O.D. of a two step gage.*

In Figure 29 for example, sheet lead is used in conjunction with the work for two reasons. Firstly, the lead sheets prevent Hard Chrome plate from being deposited on the small O.D. of the work piece. Secondly, the lead sheets assure uniform thickness of deposit on the work surface area or the large O.D. of the work. In calculating the total area for determination of the proper plating amperage, the area of the sheet lead on top and bottom of the work should be added to the work surface area.

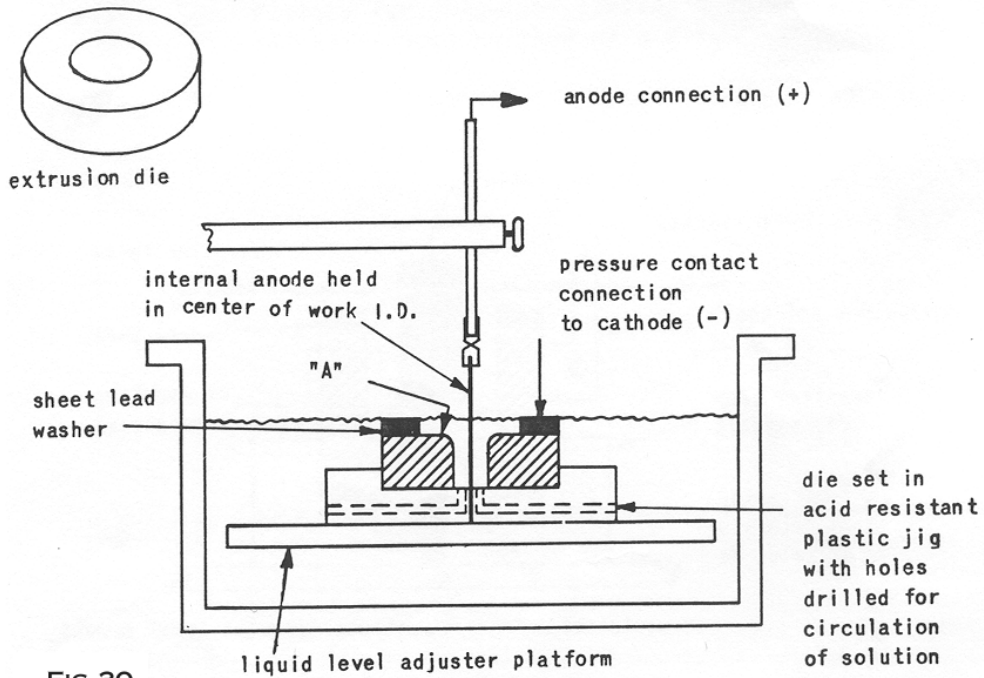

Fig 30 Shows an arrangement for Hard Chrome plating the ID of an extrusion die, where the plate must feather out to top surface at 'A'. The use of the sheet lead washer makes it possible to deposit Hard Chrome plate on the top surface of the die. The chrome, in this case, feathers or tapers in toward the lead washer.

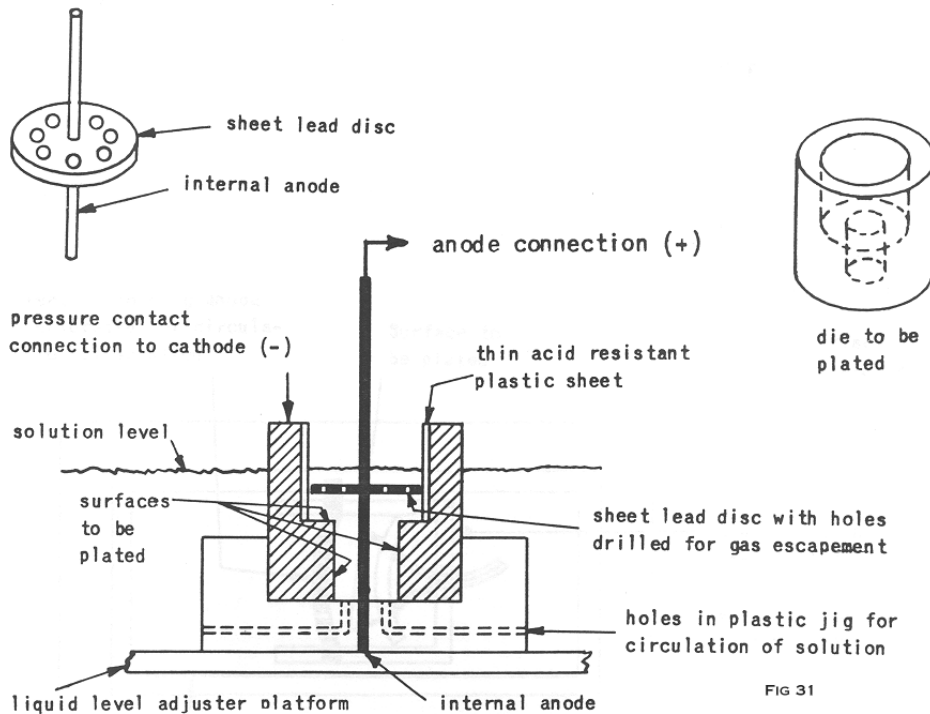

Fig 31 Shows a fixture for Hard Chrome plating both the I.D. & the horizontal surface of a die. The thin acid resistant plastic sheets prevent the Hard Chrome plate from being deposited on the large I.D. The lead sheet disc is used for depositing plate on the horizontal surface area or shelf area perpendicular to the inside diameters.

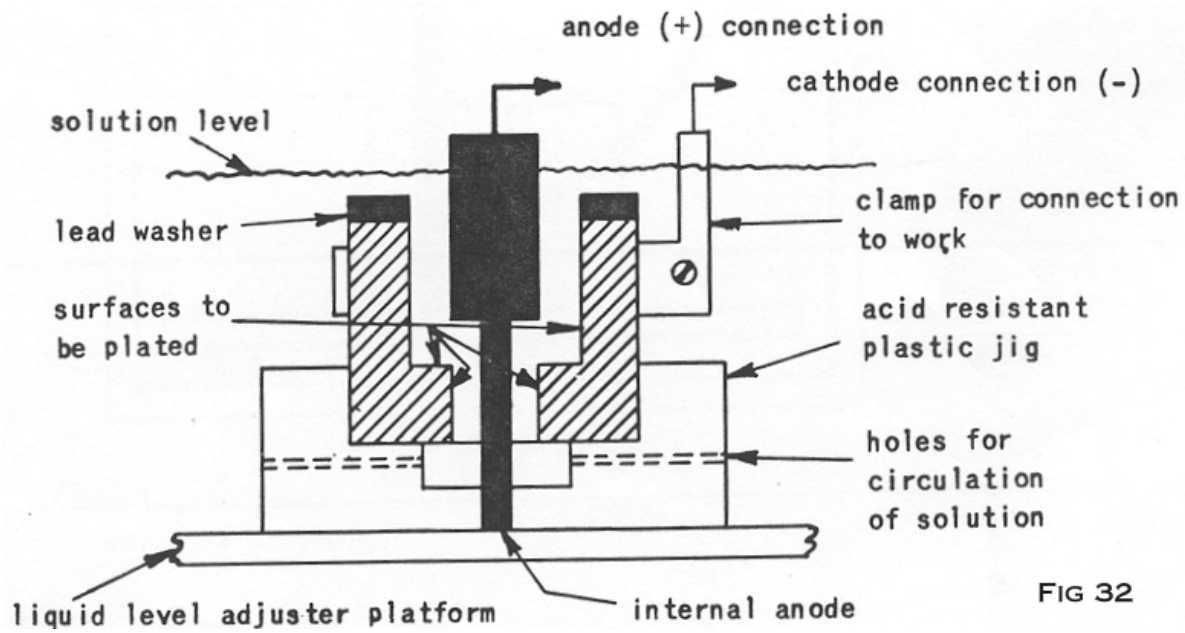

FIG 32

Fig 32. Arrangement for simultaneously Hard Chrome plating small and large I.D. of a work-piece

Figure 32 is similar to the one given in Figure 31, except the large and small inside diameter require Hard Chrome plate. The size of the internal anode should be based on the values shown in the table shown in the 'Inside Diameter Plating' section.

A perforated lead conforming anode, Figure 33, is used in conjunction with plastic jig to obtain a uniform deposit on the surface of the plate.

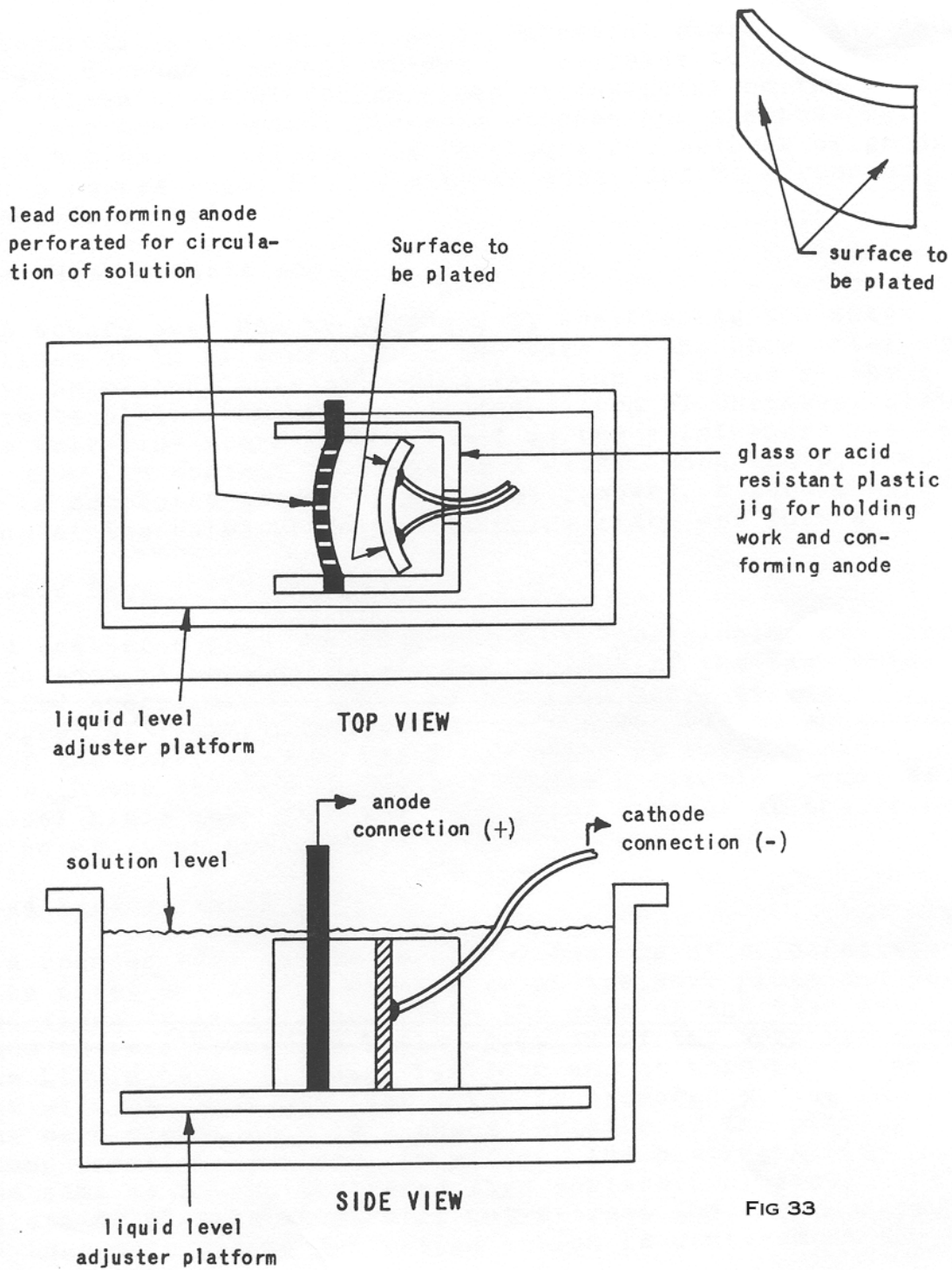
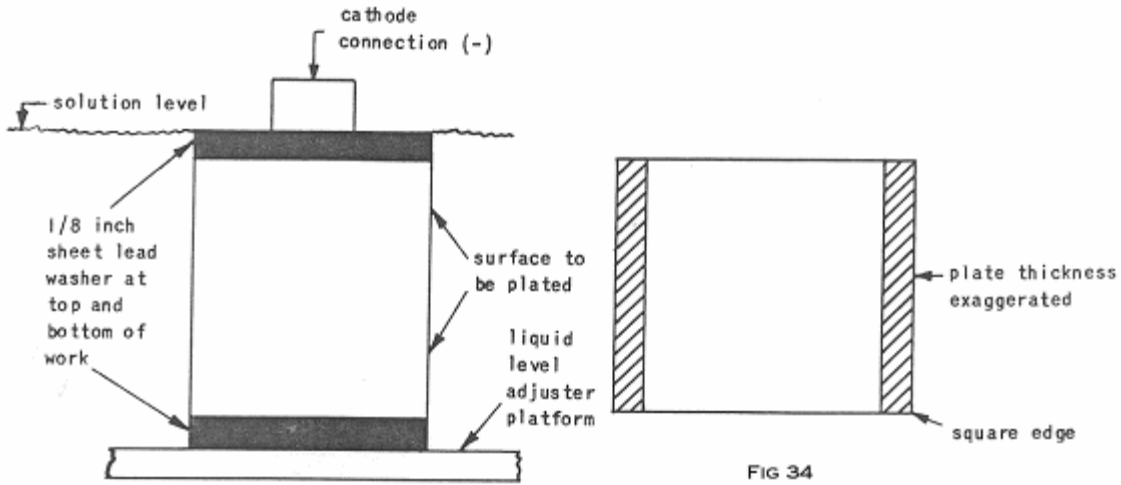

FIG 33

Fig 33. Conforming anode used for even deposition of Hard Chrome plate on the surface of an electroplate.

Controlling the deposition of Hard Chrome plate by the recommended Hard Chrome method allows the operator to produce three various types of finish edges at any point on the work piece where the Hard Chrome plate is stopped and the base metal surface begins. As illustrated in Figures 34, 35 & 36, methods of producing 1) a square edge, 2) a feathered edge, and 3) a rounded edge are explained.



Square Edge - Figure 34

A square edge can be produced by positioning the sheet lead flush or in alignment with the edge of the base metal surface to be plated, thus extending the line or plane of the surface to be plated. In the actual deposition of Hard Chrome plate, a fine hair-line crack is developed at the point where the lead sheet come in contact with the base metal. When the plating cycle is completed and the lead sheet removed, a square edge remains at the point where the hairline crack was formed.

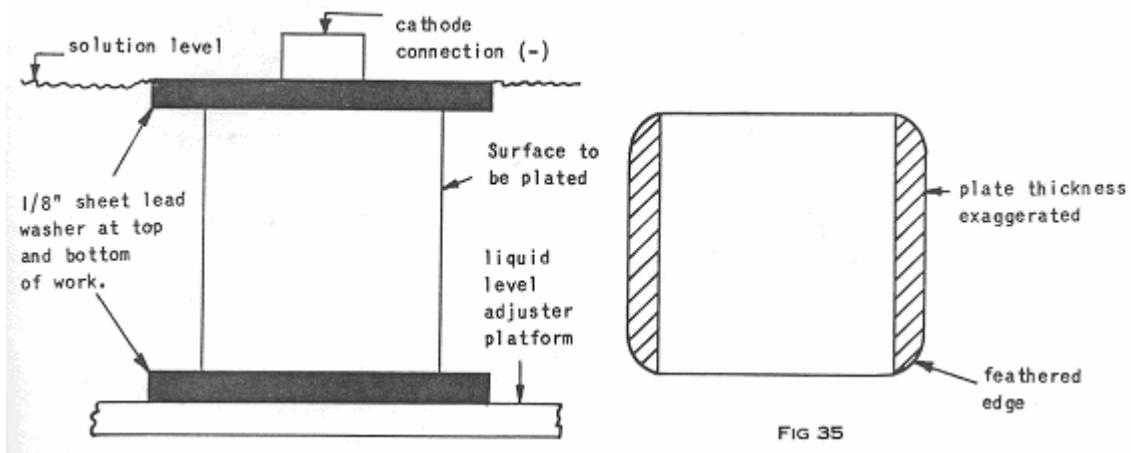

Feathered Edge - Figure 35

A feathered edge can be produced by positioning the sheet lead so that it extends beyond the surface of the base metal to be plated approximately 1/16" or slightly more, depending upon the degree of feathering desired. In effect, the extended portion of the sheet lead at the point where it forms a right angle with the base metal surface, draws a certain amount of Hard Chrome plate away from the base metal surface at the right angle point, thus producing a feathered edge.

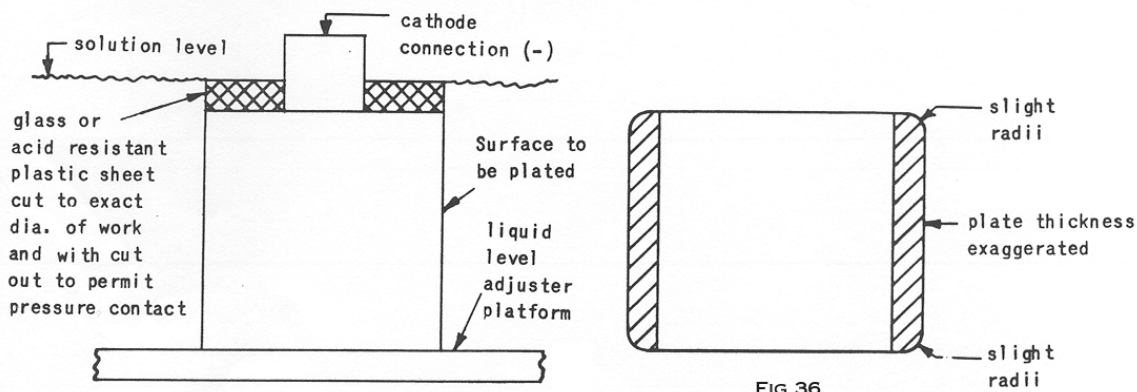

FIG 36

*Rounded Edge*                      *Figure 36*

A rounded edge can be formed by the use of acid-resistant plastic sheet cut to the exact size of the work piece and positioned flush or in alignment with the edge of the base metal surface to be plated. The bottom portion of the work piece rests on the Liquid Level Adjuster Platform and at this point the radius will be less than that which is produced at the top edge of the work piece. This is a characteristic of the plating action and cannot be avoided. In effect, the plating action here is the same as in the feathered edge application, except that the glass or plastic sheet will not attract the chrome deposition, thus more chrome deposition action is centered at the edge of the work piece.

Note: In all the illustrations and examples referred to in the preceding paragraphs on "Deposit Location Control", the use of masking tape, stop-off lacquers and plastic coatings have been limited to minor usage in the coating of the cathode surface. In the construction of jigs and fixtures, masking tape can sometimes replace clamps as a method of holding the plastic sheets or anodes in proper position.

## FINISHING AFTER HARD CHROME PLATING

### Buffing

To improve the luster on parts that require that type of finish, parts may be buffed lightly using a soft felt, or cloth wheel with the addition of commercial buffing and polishing compounds. In many cases, the parts may be hand rubbed, using a damp cloth dipped in levigated alumina. Where low micro inch finishes (2 to 10 micro inch) are required, commercially accepted polishing methods should be applied.

### Grinding and Lapping

In some instances, it is necessary to salvage parts that are excessively worn or uneven. In this application, the parts should be machined lapped or ground to a smooth, even surface before plating.

Refer to the paragraph entitled "The Importance of Base Metal Finish Prior to Plating", page 92.

If the thickness of deposit required is too great, and the tolerance is too close to permit plating to size, the part may be plated over-size and the part, finished to size by lapping or grinding.

Lapping is preferred since the grinding of a chrome plate surface is known to seriously reduce the wear resistant qualities of the chrome.

## **INTERRUPTED CHROME PLATING CYCLES**

If the plating cycle is interrupted by power failure, blown fuses or for other reasons, the following procedure is recommended in order to continue plating after correction of the electrical or other troubles:

Work should remain positioned in the plating tank, and it should not be removed from the solution.

A stripping current at 1 amp. per sq. in. should be applied to the work piece for 10 to 30 seconds, depending on the already attained deposit thickness. The heavier the deposit of chrome, the longer it takes to strip.

After stripping, the plating cycle should be continued in the normal manner as outlined in the "GENERAL HARD CHROME PLATING INSTRUCTIONS (p 92),"

Undersize Deposits -- Occasionally, when plating to dimensional tolerance, the work may be removed from the plating tank and upon measurement, be found to have less plate thickness than required. This may be caused by failure to calculate surface area correctly or failure to apply the proper current.

The work can be brought up to size by:

1. Rinse work in clean water and check for size. Avoid contamination of plated surface; **DO NOT HANDLE OR TOUCH PLATED SURFACE.**

2. Re-calculate work surface area and determine plating current. Determine the plating time required to bring work up to size (see Rate of Deposition Chart)

3. Re-immerses the work in plating bath and plate according to the "Recommended Plating Instructions". No cleaning procedure is needed prior to re-immersion in the plating bath if the work surface has not become contaminated or oxidized.

Note: Before re-immersing in the solution, make sure that the temperature of the work piece is equal to or higher than the solution temperature. If the temperature of the work is considerably below that of the solution, the deposited chrome has a tendency to laminate and the added deposit may be chipped or flaked off easily.

Oversize Deposits -- In general, for close tolerance work, oversize deposits (.0005" and below) the condition may be rectified by lapping the work piece to size. Applications where the over deposit is greater, only one alternative remains--grinding.

Heavy deposits of Hard Chrome should not be removed by stripping in the Hard Chrome bath.

## PROCEDURE FOR REMOVAL OF CHROME PLATE

The method best suited for removal of chrome deposits depends on the thickness of deposit, and the base metal material. Under normal circumstances, that is, starting with a new tool or part thoroughly cleaned as recommended, chrome plate removal after using the Caswell Hard Chrome System, is seldom necessary because of the close control obtainable over the deposit. In those instances where a poor finish caused by improper cleaning etc., it is essential that all the chrome be removed and that the work be re-cleaned before re-plating. In addition, if the work received by the Chrome operator has been previously plated with conventional industrial chrome or has been returned after use for re-plating with Chrome, the work should be processed to remove all traces of chrome before re-plating. Subsequent paragraphs will deal with removal of heavy and light deposits from ferrous and nonferrous metals.

### Removal of Chrome Plate from Industrial Steel.

**Light Deposits.** Light deposits of Chrome Plate (up to .002") can be removed by stripping in Chrome solution. This may be accomplished by following Steps 1 to 4 under GENERAL HARD CHROME PLATING INSTRUCTIONS page 92, except, maintain the stripping current of 1 amp. per sq. in. At the first signs of a constant bubbling action at the work surface or when an abrupt drop is observed in the reading of the ammeter, stripping should be terminated. The work should then be removed from the solution for examination. If after inspecting the work surface and the chrome is not removed, the work should be re-immersed and stripped until all signs of chrome have disappeared. Because Chrome plate is removed by stripping at a rate considerably faster than it is deposited, extreme caution should be exercised when stripping chrome.

**Heavy Deposits.** Heavy deposits of Chrome plate (.002" or more) are stripped conveniently using electrolysis. Some acids will remove chrome deposits, but the user is cautioned against application of acids for chrome removal from industrial steels, because of the harmful effect time may have on the base metal. The Chrome unit's direct current output is used as a source of power when using alkaline cleaners.

A good alkaline cleaning solution is prepared with 5-6 oz. ANODIZE & CHROME STRIPPER added to one gallon of water. This solution may be used at room temperature but, the stripping time is slower. Heating the alkaline solution to a Temperature of 160° F, considerably increases the rate of chrome removal. The brush plating technique is ideal for use with this solution, especially for decorative chrome plate removal.

A typical set-up for stripping Chrome plate electrolytically using ANODIZE & CHROME STRIPPER solution is shown here.

The recommended procedure is as follows:

DE-PLATING TANK SETUP

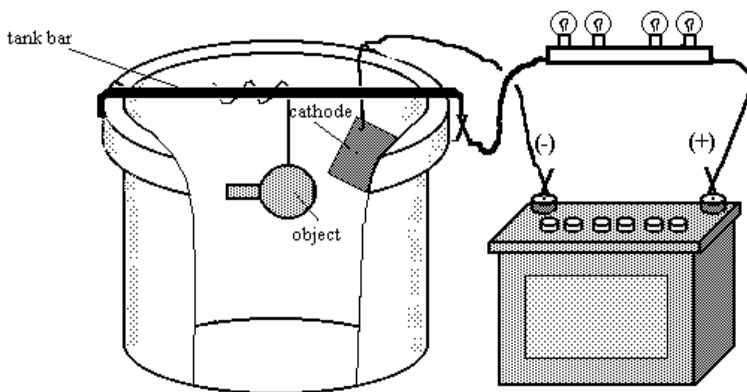

1. Connect the piece to be stripped to anode (positive) connection of your power unit, and immerse work in Anodize & Chrome Stripper Solution .
2. Connect the GP Plates to the negative terminal of your power supply.
3. Adjust current until a current density of 1/2 to 1 amp. Per. sq. in. is obtained. Maintain this current density for approximately five minutes.
6. Remove work and inspect to see if all chrome has been removed. If not, repeat cycle as outlined previously.
7. Water rinse work and clean work according to recommended CLEANING INSTRUCTIONS PRIOR TO PLATING P 108. The part is then ready for plating.

Note: The above procedure is recommended for the removal of heavy Chrome deposits (.002" or over), which have been deposited over nickel. CAUTION: EXCESSIVE STRIPPING ON THE BASE METAL AFTER CHROME HAS BEEN REMOVED IS NOT RECOMMENDED. THIS APPLIES PARTICULARLY TO HIGH CARBON STEELS. A PERIODIC FIVE MINUTE INSPECTION OF THE WORK SURFACE IS HIGHLY RECOMMENDED. (It is usually better to leave the nickel plate intact, and plate over it with copper.)



## Removal of Chrome Plate from Non-Ferrous Metals (Brass, Bronze, Copper or Nickel)

Light and Heavy Deposits -- Either concentrated or diluted hydrochloric acid can be used for removal of Chrome plate from brass, copper or nickel. In this case, no electrical current is necessary, only immersion in the acid is required.

Concentrated Hydrochloric Acid is recommended for the removal of Chrome plate from brass, bronze, copper and nickel.

Concentrated Hydrochloric Acid is always used at room temperature, the work being immersed in the solution for sufficient time to remove all the chrome deposit.

Diluted Hydrochloric Acid Solution, consisting of 1 pint of Hydrochloric Acid, slowly and carefully added to 1 gallon of water, can also be used if desired. The rate of chrome removal using the diluted solution may be increased by increasing the temperature of the solution. Usually, Hydrochloric Acid solutions are heated to approximately 125 deg F. Use acid-resistant containers and keep them covered.

**CAUTION:** Extreme care should be exercised in the mixing of the Hydrochloric Acid Solution. ALWAYS ADD THE ACID TO THE WATER SLOWLY AND CAREFULLY.

## Chrome Plating Troubleshooting







<b>Problem</b>	<b>Cause</b>	<b>Remedy</b>
No deposit. No gassing	No current (or gassing from part)	Check all contacts. Check power source.
No deposit. Work is gassing	Reversed polarity	Anodic work piece. reverse polarity
No deposit. Work is gassing	Too much acid in solution, from previous bath	Discard solution. Check & improve rinsing
No deposit. Work is gassing. Brown stains	Insufficient sulfuric acid in solution.	Add 1/2 teaspoon of battery acid, and try again.
Deposit dull or milky	Temperature &/or current balance incorrect	110f = 0.8 amps per sq". 125f = 1.45 amps per sq" Raise temp & amps for more current
Dull spots	finger prints etc. passive nickel plate rinsing problem	Clean off prints with talc, or lime Activate by dipping in muriatic acid check rinse water, use distilled water
Low throwing power	hydrogen gas is trapped Temperature &/or current balance incorrect Work is shielded from anode	Agitate the part to release gas 110f = 0.8 amps per sq". 125f = 1.45 amps per sq". Raise temp & amps for more current Move the part to a more prominent position
Pitting	surface contaminated or bubbles sticking	Improve surface cleaning
Burnt looking plate	Temperature &/or current balance incorrect. Current too high	110f = 0.8 amps per sq". 125f = 1.45 amps per sq" reduce amps or use a dummy (add more parts) to 'rob' current
Rough Deposit	amps are too high Smuts on work. suspended matter in tank	reduce amps or use a dummy (add more parts) to 'rob' current Brush off smuts. Filter solution through a double coffee filter. remove all sludge from tank bottom
Poor adhesion of Chrome plate	poor surface preparation	Check cleaning, check for oil or grease in bath. Remove old chrome before plating. Etch nickel plate prior to chrome
Partial Plate on high spot &/or edges.	Insufficient current	Clean anodes by wire wool/brush. Check anode/cathode ratio adequate, and anode distribution is even. Check sufficient power form source. Remove anodes from tank when not in use.
Iridescent color on dry chrome plate	insufficient power, or insufficient rinsing	110f = 0.8 amps per sq". 125f = 1.45 amps per sq". Raise temp & amps for more current Improve rinsing and drying procedures

## BRIGHT ACID TIN PLATING

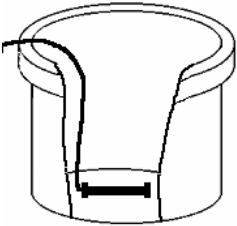
**Ideal for model Tin-ware Trains, Antique Tin-ware, Cooking Utensils, Electronics, Buss Bars, Tools and much more**

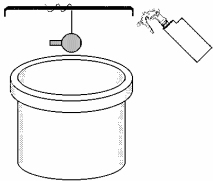
Tin is a very commonly used metal for the protection of steel. It is used extensively in the food trade because of its non-toxic qualities. Tin is a bright, shiny material, and has excellent soldering capabilities, making it ideal for all electrical connection applications.

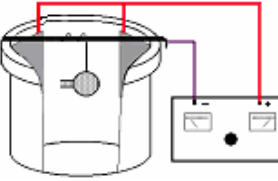
Caswell's Tin Plating kit will plate directly over, copper, steel, brass, bronze. Other more 'difficult' metals such as pot metal, will require a coat of FLASH COPPER first.

PROCEDURE	SETUP	OPERATING PARAMETERS	EQUIPMENT	SAFETY
1. SURFACE PREPARATION	Buff & Polish for a bright shiny surface Bead Blast or Nylon Abrasive wheel buff for a 'flat or satin' look.			
2. DEGREASING		140- 200 <sup>o</sup> F No agitation 5 mins immersion  12 oz SP Degreaser 3 gal Distilled water	1 x Plastic tank 1 x tank lid (1 x lid ring) 1 x 200f heater 1 x 2lb SP Degreaser	Wear rubber gloves and goggles. Do not ingest 
3. RINSE IN DISTILLED WATER SPRAY				
4. WATER BREAK TEST	 <i>Oil/dirt film makes water bead up part</i> <i>No oil/dirt film allows water to cover part</i>			
6. Tank Makeup		Temp – 65-80 F 2 x Tin Anodes  10 milli-amps per sq” 1-4 volts approx  pH = <1	1 x plastic tank 1 x tank lid (1 x tank ring) 2 Tin Anodes Tin Concentrate Tin Activator Distilled water Battery Acid	Wear rubber gloves and goggles. Do not ingest 
7. Plating Times	Average thickness is typically 0.0002-3” (0.0001” in 10 mins)			

Setup involves mixing 2 quarts of battery acid into 3.5 quarts of distilled water, then adding one quart of Tin Concentrate and 1 pint of Tin Activator.

The Caswell Tin Plating System is a stable bath, which deposits a leveled, brilliant plate with excellent soldering capabilities. It has a wide operating range in regard to concentration and operates well with low tin concentration.

Do not use air agitation, as the bath will froth violently due to the wetting agents used.

Copper Cook ware is often lined with tin. Usually molten tin is 'hand wiped' into the cleaned pot. However, lining can be done quite easily by the following electroplating technique.

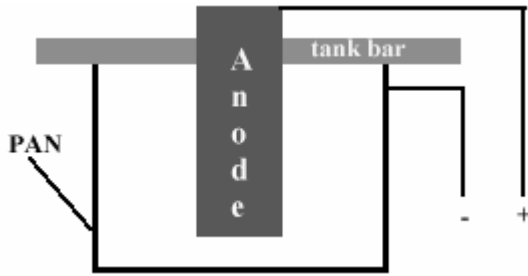

Clean the inside of the pot thoroughly with an abrasive cleaner such as Soft Scrub. Buff and polish to an acceptable shine. Fill the pot to the brim with pickle # 2 and let soak until the entire inside is a pink color.

Rinse thoroughly in hot water.

Fill the pot to the brim with Tin Plating solution which has been preheated approx 80 degrees.

Make a suitable tank bar from PLASTIC or some other NON CONDUCTOR

Connect the positive wire from your power supply to the Tin Anode, and the negative to the cooking pot. Plate in the normal manner. The pot should keep the liquid around the optimum operating temp of 72 deg f, especially if the start up temp is raised to 80, as previously suggested.

## **BLACK KROME**

Black Krome plating solution provides a distinctive finish suitable for a wide variety of articles. Any black finish, ranging from matte to a brilliant luster, can be obtained. Matte finishes have been found suitable for industrial and military instruments, cameras, microscope and binocular parts. Articles requiring lustrous finishes include tubular furniture, plumbing fixtures, buttons, fishing lures and trophies. Surfaces can be mechanically relieved to provide highly desirable antique finishes suitable for casket hardware, jewelry, buckles and lamps. The appearance of the antique finish is altered by the substrate on which the black Krome coating is applied, e.g., copper, zinc, nickel, etc.

Black Krome will plate over zinc, nickel, copper, steel, sintered metal, tin and lead. It will not plate over pot metal, pewter, stainless steel or aluminum, which should be treated and copper plated, then nickel plated if desired, first.

Black Krome comes ready to use. Do NOT dilute.

It is best applied to a nickel base on ferrous metals, where it will give a smoky black metallic appearance. On copper, the blackness will be more pronounced.

Adhesion and performance of the Black Krome can be enhanced by an acid etch in pickle # 4. Soak for 30 – 60 seconds before plating. Then rinse thoroughly before Black Krome Plating.

To obtain a matte finish, the part should be bead blasted to a dull finish prior to plating.

For best results, you should have an air supply or agitator blowing bubbles into the tank.

After plating with Black Krome, buff the part to a high shine using a loose cotton wheel and blue compound, then soak in hot SP Degreaser to remove buffing greases etc.

Plate for approx. 1-3 minutes.

The shiny appearance of Black Krome plate can be enhanced by several factors.

5. Buffing and polishing PRIOR to plating, is by far the most important factor.
6. Buffing and polishing AFTER plating,
7. Protecting the surface by applying Collinite Metal Wax or a clear lacquer.







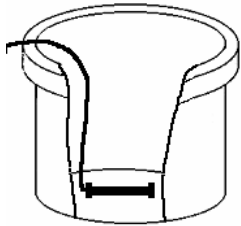

### **DISPOSAL OF BLACK KROME PLATING SOLUTION**

#### **Electro-Winning**

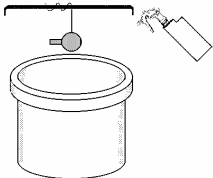
The bronze can easily be plated out using scrap iron or steel nails. The bronze metal in the bath can be reduced to levels acceptable to local authorities.

#### **Precipitation**

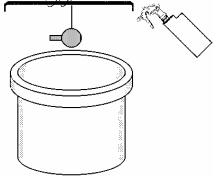
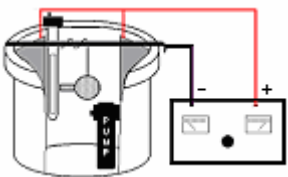
Precipitation of the bronze metal can be achieved by raising the pH to 10-11 using sodium hydroxide or by lowering the pH with Hydrogen Sulfite to 3-4. Using either method, the copper and tin metals in the bath will drop out of the solution. It may then be disposed of accordingly.

PROCEDURE	SETUP	OPERATING PARAMETERS	EQUIPMENT	SAFETY
1. SURFACE PREPARATION	Buff base metal to a high shine prior to plating.			
2. DEGREASING		140- 200°F No agitation 5 mins immersion  12 oz SP Degreaser 3 gal Distilled water	1 x Plastic tank 1 x tank lid (1 x lid ring) 1 x 200f heater 1 x 2lb SP Degreaser	Wear rubber gloves and goggles. Do not ingest 
3. RINSE IN DISTILLED WATER SPRAY				
4. WATER BREAK TEST	  <p>Oil/dirt film makes water bead up                      No oil/dirt film allows water to cover part</p>			
5. SOAK ETCH		temp 65-80 °F Make up pickle #1 solution (2.5 gals Water – 1 pint muriatic acid 30 – 60 seconds	1 x Plastic tank 1 x tank lid (1 x lid ring) Muriatic Acid & Distilled water=Pickle # 1	Wear rubber gloves and goggles. Do not ingest 
6. RINSE IN DISTILLED WATER SPRAY				
7. CALCULATE TOTAL SURFACE AREA				
8. TANK MAKEUP		140°F Agitation (pump)  Electrolyte is supplied ready for use. Do NOT dilute .25 amps per sq” 4 volts pH = 11.5	1 x 300W Heater 1 x Thermostat 1 x plastic tank 1 x tank lid (1 x tank ring) 2 Stainless Anodes 1 x filter/pump Black Krome Solution.	Wear rubber gloves and goggles. Do not ingest 
9. PLATE TIME	Plate for approx 1 - 3 minutes to desired color.			
10. HOT WATER RINSE	Rinse with hot water and dry free of water marks.			
10. REPLACE LOST WATER	After plating, top up the tank with CITY WATER to the original waterline. Do not use distilled water as this will reduce the pH of the solution.			
11. BUFFING	After plating with Black Krome, buff the part to a high shine using a loose cotton wheel and blue compound, then soak in hot SP Degreaser to remove buffing greases etc.			

# BRASS PLATING

## Cyanide Free Brass Plating

**Caswell Brass** is a unique cyanide-free alkaline brass plating system which plates a true 70/30 yellow-green plate directly onto steel and bright nickel plated surfaces. It contains no strong chelating agents making it very environmentally friendly. It is used as a bright brass flash over nickel-plating process. It is the preferred system for heavy brass plating which will be antiqued (oxidized and relieved). It may also be used for decorative heavy brass if the surface is burnished or buffed and colored with a wheel to remove the slight haze and reveal the true rich brass color for lamp parts, hardware and plumbing fixtures.

Zinc die-castings must receive a strike plate of Pot Metal Treatment. Zinc plated steel must have the zinc removed by soaking in a 5% muriatic acid etch, followed by bead blasting or buffing.

**Caswell Brass** is supplied as a ready-to-plate solution, which includes all components except **Caswell Brass** brightener. When making 10 gallons of solution 9.5 gallons of **Caswell Brass A** and 0.5 gallons of **Caswell Brass B** are required.

\*Note: A higher anode to cathode area may be desirable and can be accomplished by using stainless steel anodes.

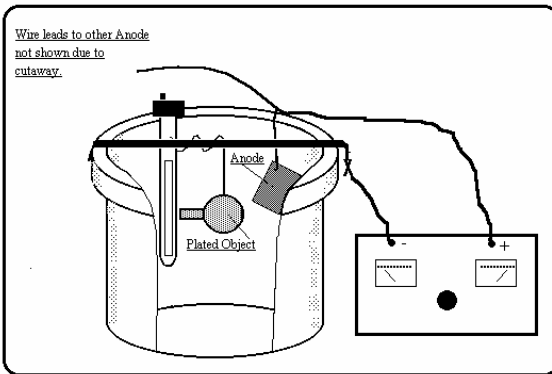







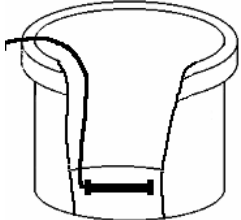

### Potassium Hydroxide Control

Potassium hydroxide (KOH) is used in the solution for conductivity, anode corrosion and it aids in the control of the color of the brass deposit. If the pH is too low, copper will deposit in the low current density area. This can be corrected by a simple addition of KOH (the 45% liquid is the most convenient for adjustments) to raise the pH. The pH must be checked frequently and maintained between 13.0 and 13.5 if satisfactory results are to be obtained. It must be checked at least daily and every four (4) hours with very heavy production.

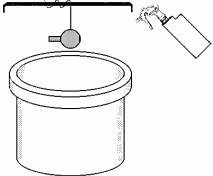
### Post Plate

Due to the high pH of the **Caswell Brass** plating solution, thorough rinsing of the alkaline film is necessary before antiquing, buffing, burnishing or lacquering.

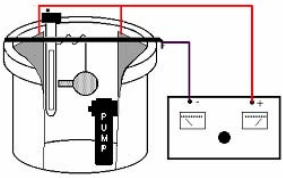
**Caswell Brass** plating solution is alkaline (potassium hydroxide) and can cause severe burns. Do not get in eyes, on skin or clothing. Wear eye protection (glasses, goggles, full face shield), rubber gloves and apron when preparing solutions and making additions to the solutions. In case of contact, immediately flush skin or eyes with plenty of water for at least 15 minutes. For eyes, call a physician.

PROCEDURE	SETUP	OPERATING PARAMETERS	EQUIPMENT	SAFETY
1. SURFACE PREPARATION	Buff & Polish for a mirror finish. A more yellow finish is obtained over a copper base, but Brass may be plated directly onto steel			
2. DEGREASING		140- 200 <sup>o</sup> F No agitation 5 mins immersion  12 oz SP Degreaser 3 gal Distilled water	1 x Plastic tank 1 x tank lid (1 x lid ring) 1 x 200f heater 1 x 2lb SP Degreaser	Wear rubber gloves and goggles. Do not ingest 
3. RINSE IN DISTILLED WATER SPRAY				
4. WATER BREAK TEST	 <i>Oil/dirt film makes water bead up part</i>  <i>No oil/dirt film allows water to cover</i>			
5. CALCULATE TOTAL SURFACE AREA AND PLATING TIME				
6. Tank Makeup	 	80-110 <sup>F</sup> Agitation (pump) Brass Part A Brass Part B (Do not dilute) 3-12 volts approx 0.01 – 0.30amp per sq” 5-15 mins pH = 13 – 13.5	1 x 110° Heater 1 x plastic tank 1 x tank lid (1 x tank ring) 2 Brass Anodes 2 Anode Bandages 1 x filter/pump 1 x pH meter	Wear rubber gloves and goggles. Do not ingest 
7. Plating Times	15 - 30 minutes			
8. Replace lost water	After plating, top up the tank with DISTILLED water to the original waterline.			
9. Buff & Polish	Buff and polish to enhance the finish, using BLUE buffing compound & Canton Flannel wheel			
10. Wax	If the brass is your finished product, apply a coat of Collinite Metal Wax, or VHT Genuine Clear Lacquer See the section on antiquing solutions for several interesting brass patinas			



## **COPY CAD® & ZINC PLATING**

### **NEW FORMULA AS OF 6/29/06**

Do not mix our new Copy Cad® and Zinc Plating Formula with our old formula.

Zinc and cadmium plating are somewhat unlike most other types of plating in that they are sacrificial to underlying steel. Over time, the coating gives up its life to protect the underlying metal from rusting. As this happens, the coatings develop a dullness, which eventually turns to a whitish powdery surface. This is the 'rust' of zinc, an oxide. When the life of the zinc/cadmium is over, the part will begin to rust. If these types of sacrificial coatings damaged, a scratch as an example, the coating forms a protective film of oxide over the scratch, preventing it from rusting. This is unlike other types of plate, such as nickel, where the edge of the damaged coating would begin to rust, and it would eventually get under the nickel and push it away from the steel.

Life expectancy of these coatings may be pre-determined by the thickness of the coating. However, a given thickness in one situation may last much longer in a less harsh environment.

Cadmium and Zinc plates do not cope well with acid environments, and premature accelerated action may take place, reducing the life of the coating. This can be reduced by 'chromating' the parts, or treating with a lacquer etc.

When removing old cadmium plate, consider that the metal removed is highly toxic. It is very inadvisable to remove this using abrasive means, which may produce an airborne breathable dust.







The operating instructions for Copy Cad® and Zinc plating kits are the same, except that Copy Cad® does not use Brightener and the surface is prepared to provide a dull flat finish.

To achieve the flat dull gray look of Copy Cad® or cadmium, treat the surface to provide a dull finish immediately before plating. Either bead blasting, or cleaning with the nylon abrasive wheel, which is included in all Copy Cad® kits, best achieves this. Mount the wheel on a bench grinder or fast electric drill. Copy Cad® does NOT use any brightener, as this addition to the solution will produce a bright shiny surface, which is undesirable.

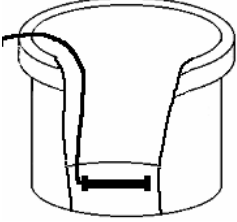
The Zinc plating kit requires that the surface be reasonably shiny before plating. Light buffing and polishing will provide an adequate pre-plate surface. Add ZINC BRIGHTENER to the plating solution to maintain the bright shiny appearance of the zinc plate. If for some reason, you obtain a dull grey heavy plate, then a simple way to brighten this is to use a WIRE WHEEL on the part and buff it lightly. It will shine up to a 'store bought' finish in no time.

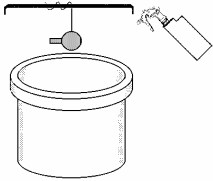
Copy Cad® & Zinc Plate will also accept numerous chromates, which allows you to color the finish. A popular color for cadmium and zinc is a golden yellow. This can be achieved with our Yellow Chromate system. Immerse the plated part in the chromate solution. When the desired color is reached, remove the part and rinse in distilled water

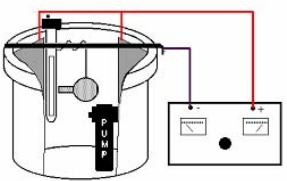
When plating cast iron with Copy Cad® or Zinc, it is advisable NOT to soak the parts in acid pickle, but bead blast them instead.

COPY CAD® & ZINC PLATING				
PROCEDURE	SETUP	OPERATING PARAMETERS	EQUIPMENT	SAFETY
1. SURFACE PREPARATION	Light Buff & Polish for a Zinc Plate look Bead Blast or Nylon Abrasive wheel buff for a Cadmium look.			
2. DEGREASING		140- 200 <sup>o</sup> F No agitation 5 mins immersion  12 oz SP Degreaser 3 gal Distilled water	1 x Plastic tank 1 x tank lid (1 x lid ring) 1 x 200f heater 1 x 2lb SP Degreaser	Wear rubber gloves and goggles. Do not ingest 
3. RINSE IN DISTILLED WATER SPRAY				
4. WATER BREAK TEST	 <i>Oil/dirt film makes water bead up part</i>		 <i>No oil/dirt film allows water to cover</i>	
5. CALCULATE TOTAL SURFACE AREA AND PLATING TIME 6. OPTIONAL ACID ETCH IN 5% MURIATIC ACID/WATER SOLUTION FOR 2-3 SECONDS				
7. Tank Makeup		110 <sup>o</sup> F Agitation (pump) 1 Qt Zn/CC Crystals per 1.5 gals of DISTILLED WATER  ½ teaspoon Zn Brightener 0.14 amps/sq in pH = 5.5 - 6	1 x 300W Heater 1 x Thermostat 1 x plastic tank 1 x tank lid (1 x tank ring) 2 Zn/CC Anodes 1 x filter/pump C Cad Crystals Zinc Brightener Distilled water	Wear rubber gloves and goggles. Do not ingest 
8. Brightener Additive	Zinc Brightener should be added, as required, ½ teaspoon at a time. <b>DO NOT ADD IF A CADMIUM FINISH IS REQUIRED.</b>			
9. Plating Times	Immersion time depends on plating thickness			
	<b>Time</b> 20 mins 30+ mins	<b>Application</b> Most applications, including chromating Highly corrosive environments	<b>Plate Thickness</b> 0.001”	
10. Replace lost water	After plating, top up the tank with DISTILLED water to the original waterline.			
11. Chromate	<ol style="list-style-type: none"> <li>1. Immerse in 2-5% muriatic acid solution for 3 seconds.</li> <li>2. Rinse, remove, then rinse again.</li> <li>3. Yellow, Black, Blue, Olive Drab Chromate</li> </ol> Chromates require 20 mins zinc plating time to work effectively			

## SURFACE PREPARATION for COPY CAD®

The most important part of Copy Cad® plating is to achieve a dull 'flat' even finish to the metal prior to plating. Any shiny areas will make the Copy Cad® plate shinier, which will look more like a zinc plate.

There are several ways to achieve this 'flat' finish.

A Nylon  
Abrasive  
wheel  
(supplie  
d in the  
Copy  
Cad®  
kit)



A  
SCRUBBE  
R wheel. A  
cool  
running  
wheel made  
of an  
abrasive  
'cloth'  
impregna  
ted with a  
fine  
abrasive  
aggregate.  
Leaves a  
fine satin  
scratch  
brushed  
effect



Bead  
Blasting.  
Using a  
fine  
glass  
bead,  
this  
cleaning  
techniqu  
e  
surpasse  
s all  
other for  
the right  
effect.

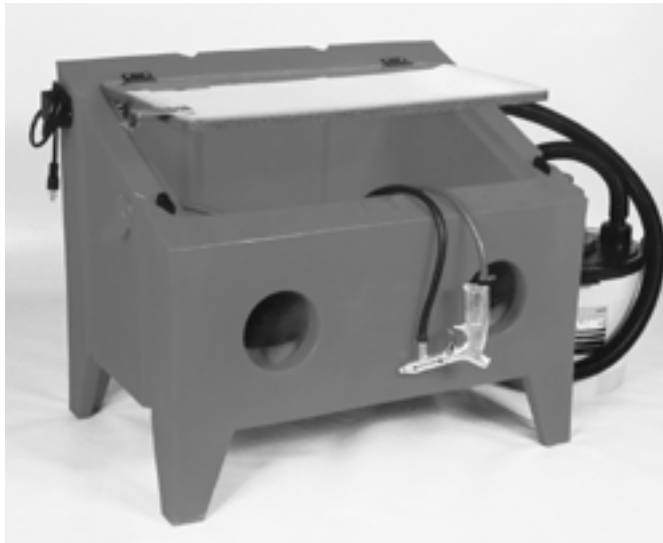

## SURFACE PREPARATION for ZINC PLATING

Most commercially zinc plated items will not have had too much preparation done to them. They will not have been highly polished, merely cleaned well. Usually the steel is fairly clean and new, so it has a certain amount of shininess to it. The parts may be polished or left without any work. The overall end result will vary depending on the final surface preparation. The additional of ZINC BRIGHTENER to the solution will make them plate shinier than COPY CAD®, even on a dull flat surface.

Plate a dummy piece of metal for about 30 minutes to purify the system, prior to plating your first work piece. (You will only need to do this again, if you think the solution is contaminated)

## OPERATING THE COPY CAD® & ZINC PLATING SYSTEMS

When adjusting the amperage, keep an eye on the bubbling effect from the plated part. This should have a small amount of bubbles, an effervescence, coming from it. If the plating solution froths, turn down the current. You will need to turn off the air agitation to view these bubbles.

Remember, the thicker the plated coating, the longer it will last.

Timing is everything. Smaller nuts, washers and bolts can be done with excellent results in 8-12 minutes, while larger ones can take up to 15-20 minutes. By watching the bubbles and the reaction rate of the part being done, one notices that the bubbles or foam begins to dissipate once the process is almost finished. By removing the part and dipping into fresh water, you can check the texture of the finish.

The finish can vary from a flat silver cad color to a shiny almost chrome finish. This is the result of bead blasting versus cleaning material with a fine grinder pad. Bead cleaning is recommended, as your finish will be true to the cad finish.

The pH range of the solution is 5.5 to 6.0. Lower with hydrochloric acid. You should not have to raise it but use ammonium hydroxide to do it. The bath can run as low as 4.7. So if you lower it too much, there is no need to re-adjust. pH's below 4.5 can cause the starter chemical to be removed from the solution, pH's above 6.3 can precipitate zinc.

### **Notes on Plating Cast Iron**

Cast iron needs current. 25 square inches is about .2 square feet. So you will need at least 20 amps per sq. ft X .2 = 4 amps to plate a part. The part might need activation. Make up a 10% solution of muriatic acid and water and soak the part for a minute or two then rinse, then plate.

Finally, make sure the bath is in spec. Keep the pH below 6 and add 0.5% starter (call us for this chemical). Good agitation of the plating solution also helps. Iron is a contaminant but usually only causes the part to turn black in post plate operations, i.e. nitric acid dip or chromate conversion coating.

5 mls of 3% hydrogen peroxide will precipitate the iron.

<b>Problem</b>	<b>Cause</b>	<b>Remedy</b>
No deposit	No current (or gassing from part)	Check all electrics
Plate peels off or blisters	Poor preparation Inadequate cleaning High current	<i>Improve all cleaning aspects</i> Check part with 'water-break' test. Acid etch part. Check SP Degreaser is OK. Lower current
Blackish discoloration	Impurities in solution (copper or cadmium)	Plate a dummy for 20 mins.
Rough Plate	Amps too high Suspended particles in solution	Reduce current 0.14 amps/sq in surface area. Filter solution (no charcoal)
Overall haze	Low brightener Poor cleaning Inadequate agitation	Make one brightener addition Improve cleaning Increase air agitation
'Burnt' Plate (Dark grey)	Too much current	Lower the amperage Raise the bath temperature
Slow plating speed	Low zinc level Weak pickling solution	Increase anode surface area Make up new pickle solution
Bright plate on high areas only	Insufficient Brightener Insufficient current	Make one brightener addition Increase amperage
Bright plate except very low spots	Too much Brightener	Remove by filtering through charcoal, then replace
Dull or blotchy plate	Insufficient Brightener Part not polished properly Poor cleaning	Add brightener Strip the plate off and re-polish, or plate with copper, polish the copper and then re-plate. Improve all aspects of pre-clean.
Blistering	Poor cleaning or pickling Metallic contamination High current Low zinc level	Improve pretreatment Plate a dummy for 30 minutes. If unsuccessful, dump solution and make a new mix. Lower current Increase anode surface area
Black fingerprints on plated parts	Body acids attack freshly plated zinc	Refrain from touching freshly plated parts with fingers for at least 4 hours. Use a light abrasive cleaner to remove marks.
Patchy plate, plating thickly and erratically. Lumpy and shiny	Low in chemical concentrate.	Add more Zinc Concentrate until problem disappears.

## CHROMATE PROCESSES

Chromating is a process used primarily on zinc plating, zinc die casting (pot metal), and cadmium plating. 'Golden Cad' is really a cadmium plate that has been 'chromated' with a yellow chromate.



Zinc and cadmium are electroplates or metals which are readily attacked by mild acids, and will deteriorate rapidly, even if daubed lightly with tomato ketchup! To 'harden' the plate it is placed in a mild solution of special acid (Yellow Chromate or Drab Olive Green). This slightly attacks the plate, oxidizing it. The oxide forms a tough corrosion resistant crust, which protects the softer zinc or cadmium metal.

Chromates will only work on zinc die cast (pot metal), or parts previously plated with zinc, cadmium or Copy Cad. Prepare the part for chromating by zinc or 'Copy Cad' plating steel, or bead blasting pot metal. The plate needs to be in excellent condition, fresh and bright, otherwise defects will occur in the treatment. Do not handle the parts with your bare hands prior to dipping, as you will leave body oils in the form of fingerprints, which will show up on the finished item.

Old pot metal, (probably 25 years +) these parts need to have fresh metal exposed without any oxidation present. To achieve this on carburetors, blast clean with baking soda and then rinse off in fresh water before dipping. If the result is blotchy, then blast clean again, and zinc plate the part to provide an even, fresh layer of zinc over the part.

NB. Baking Soda dissolves in water and will therefore not clog any important carburetor ports.

When using any of the following processes, it is important that the parts are rinsed thoroughly and they are allowed to dry overnight before handling.

**1. Iridescent Yellow Chromate** Process has an oily look to it, with ripples of yellows, blues and greens. It is commonly found on brackets, brake boosters and carburetors.



The Yellow Chromate Crystals are acidic! Make sure you read the labels and MSDS before use!

a. **YELLOW IRIDESCENT FINISHES.**

Add 1 gal of DISTILLED WATER to a plastic tank  
Add 1 oz of CHROMATE CRYSTALS.

b. **DEEP YELLOW - BRONZE FINISHES**

Add 1 gal of DISTILLED WATER to a plastic tank  
Add 2 oz of CHROMATE CRYSTALS.



### Using the Iridescent Yellow Chromate

Raise the temperature of the solution to 80 deg. F - using your immersion/aquarium heater.

Hang the part from a copper wire and immerse in the solution for 30 seconds (or until the correct color is achieved) swirling it to agitate. Remove and rinse in fresh water (Failure to do this will result in the part continuing to darken beyond the desired color). Set aside and air dry using a small fan.

Variations on the amount of chromate crystals will achieve different effects. Less chromate will produce a light brass color and more will produce a dark bronze. Experiment!

When the process seems to no longer work effectively, add more crystals to the solution, or discard and make up a new batch. The latter is preferable if you are trying to achieve a constant result.

Store the unused liquid in a glass container, in a locked cupboard.

## 2. Olive Drab Green Chromate

Olive Drab Green Chromate is a single dip process consisting of two components. Olive Drab #1 & Olive Drab #2. The color is usually found on carburetors. The system is specifically designed to provide a Olive Drab Green color to previously zinc plated parts as well as pot metal. The chromate system only works on zinc metal (pot metal), zinc plate or cadmium, so all parts should be either manufactured from pot metal, coated with zinc or cadmium plate. The system may also be used on 'Copy Cad' plate. The finish has performed well in salt spray tests.



### Handling Olive Drab Concentrate

Both these chemicals are corrosive. Wear gloves and face protection before opening and during use.

### Preparation of the Olive Drab Dip

In a plastic pail (HDPE preferred) place 2 gallons of distilled water.

- Pour in all of the Olive Drab # 1
- Pour in all of the Olive Drab # 2



Mix the solution carefully, avoiding splashing. The solution is now ready for use.

### Using the Olive Drab Green system.

Raise the temperature of the Olive Drab Green solution to 80 deg F, using your immersion/aquarium heater.

Hang the part from a copper wire and immerse in the solution for 30 seconds (or until the correct color is achieved) swirling it to agitate. Remove and rinse in fresh water (Failure to do this will result in the part continuing to darken beyond the desired color). Set aside and air dry using a small fan.

Problem	Cause	Solution
Dull streaks/bare spots	Poor rinsing after plating	Increase rinsing/agitation
Bronze to reddish color	Temperature too high	Lower Temperature
Olive color too iridescent	Solution too weak	Evaporate off some water
Dull powdery film, not adhering	Rinse of air drying too hot	Adjust to 120 deg F or less
Poor corrosion resistance	Temp. of drying is over 160 deg F. Leaches out chromate	Reduce temperature Reduce temperature
Poor dye absorption	Immersion time in dye too short Dye temperature too low Chromate film too thin	Increase immersion time Increase temperature Increase dip time
Chromate wipes off	Can occur is the concentration is low or high, most commonly high	Immerse the part in the yellow chromate for 10 seconds with mild agitation. If the chromate wipes off, add 0.5% by volume chromate and retest. If the wipe off is still evident, increase the immersion time to 20 seconds

## COPY CAD & ZINC BLACKENER

Copy Cad & Zinc Blackener is a black conversion finish for zinc die cast and zinc plated surfaces. It operates at room temperature (70 deg F) and produces a dense black finish which is hard and uniform, with no rub-off. When sealed with Penetrating Sealer or a wax product, it can be used as a direct replacement for black chromates or black oxides, with comparable appearances and corrosion resistance, and higher hardness. The system affords much better corrosion resistance than the Black Oxide system, as the underlying Zinc or Copy Cad plate gives cathodic protection to the steel.

Copy Cad & Zinc Blackener contains no chromates and generates no hazardous fumes.

### Preparing the solution.

Use ceramic lined metal tanks, or any plastic container.

Mix 1 part of the concentrate to 9 parts of distilled water. (1 pint Zinc & Copy Cad Blackener, to 9 pints water, etc)

### Surface Preparation

Parts that are freshly plated with Copy Cad or Zinc plate may be moved directly to the Copy Cad & Zinc Blackener system, after rinsing in fresh water.

Older zinc die castings (pot metal) should be blast cleaned with either glass beads or baking soda to remove the oxide layer. Some parts may not blacken evenly. In this situation, blast off the defective coating, then 'etch' the metal by immersing in a solution of 5% battery acid and 95% distilled water for 60 seconds. Thoroughly rinse in fresh water, then repeat the blackening process.

To blacken the parts, simply immerse in the made up solution until uniformly black. The immersion time will depend on the bath temperature. Agitate the parts to remove air bubbles etc.

Rinse the parts in fresh water and allow to dry. Do not handle the parts for at least 1 hour.

Seal the surface with any of the following products.

Penetrating Sealer (from the Black Oxide system)

WD40

Collinite Metal Wax or any other wax.

### Bath Maintenance.

The black coating is the result of a chemical reaction between the concentrate and the zinc surface. Chemical activity is gradually diminished with use, but it may be restored to the desired strength by periodic small additions of the concentrate.

When not in use, cover the tank to avoid water evaporation. The active ingredients do not evaporate.

Black chromates rarely wipe off. The pH can be low on a new makeup. So immersion times of 20 to 30 seconds are common when new. Once the chromate is aged, a pH of 2.2 - 2.8 is common. The aged black chromates are easier to use. Chromates cannot be wiped with liquids after they are applied. If the liquid has an acidic or alkaline pH, it will dissolve the chromate.

### Zinc Plating Bright Dip

As an option, dip the plated part for a few seconds into a solution of 1% sulfuric acid (battery acid) and rinse in distilled water





## SILVER TANK PLATING

Caswell Silver is alkaline plating solution, which can plate bright silver for electronic, industrial and decorative uses. It contains no cyanides and operates at room temperature.

Caswell Silver can plate directly on silver, brass, bronze and copper and does not require a separate silver strike on these substrates. The system has exceptional covering and throwing power. It produces fine-grained, smooth, dense, hard silver plate with low porosity and excellent bonding properties. The plate may be buffed for a high luster.

Caswell Silver plates substantially faster than cyanide silver and with superior adhesion. It exhibits superior color of a brilliant white. It is cost effective because it plates out of the silver anodes rather than the solution. Caswell Silver is easy to maintain with a single maintenance additive and is a very stable bath. The system is supplied as a liquid concentrate, Part A, which contains 4 oz/gallon of silver. The concentrate is diluted with distilled water.

### Plating Specifications:

	<b>Optimum</b>	<b>Range</b>
Silver Metal	2.0 oz/gal	1.5-2.5 oz/gal
pH	8.8	8.5-9.5
Temperature	68°F	60-75°F
Cathode current density	3 - 10	2-20 ASF
Anode current density	--	2-10 ASF
Agitation	air agitation on the anodes and the workpiece	







### Charging a New Bath

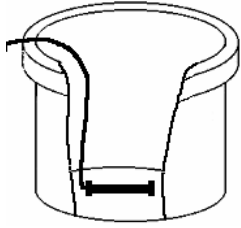
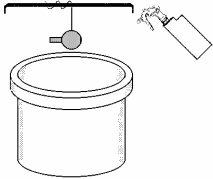
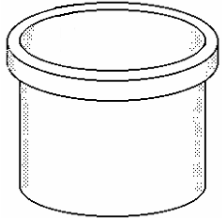

	<b>Optimum</b>	<b>Range</b>
<b>Silver</b> Part A concentrate	<b>50%</b>	<b>40-60%</b>
<b>Silver</b> Part B electrolyte	<b>5%</b>	
Distilled Water	<b>45%</b>	<b>55-35%</b>
45% KOH (Potassium Hydroxide) solution to adjust pH to 9.0		

### Equipment and Operation:

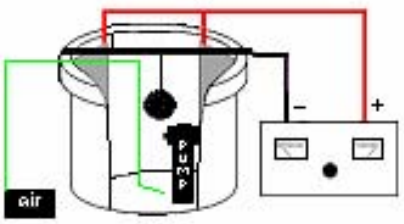
Anode	Pure silver anodes
Anode/cathode ratio	A 2:1 anode to cathode ratio is required. Calculate the maximum cathode area before setting up the process and insure the anode area is at least two times the maximum workpiece area.
Filtration	The solution must be kept free of suspended matter in order to prevent roughness. Continuous filtration with the carbon filter is recommended. New filter cartridge must be flushed prior to use by circulating DI water through the cartridge. A sulfur-free carbon pack must be maintained in the bath and changed weekly if the system is used daily for more than 4 hours
Tank	Air agitation of the anodes and cathodes is required.
Solution Adjustments	<p>The pH of the solution must be maintained within 8.5 – 9.5 for best results. If the pH meter reads 10 or higher, you need to lower it by adding a SMALL quantity of Nitric Acid.</p> <p>We do not sell Nitric Acid. It is available from Fisher Scientific Inc. Product # AC61320-5000 <a href="https://www1.fishersci.com">https://www1.fishersci.com</a> )</p> <p>If the pH meter reads lower than 8 you need to raise the pH by adding a small quantity of KOH. KOH is supplied in the kit in pellet form. Measure out about ½ cup distilled water and add approx 2 teaspoon of KOH – slowly. Allow the water to cool. Then add to solution one tablespoon at a time, taking pH readings about 10 minutes after the addition.</p> <p><b>BOTH NITRIC ACID AND KOH (Potassium Hydroxide) are extremely unpleasant chemicals to handle. Wear eye and skin protection and take extreme care.</b></p>
Part B additions	Part B is the brightener, which gives the silver plate a shinier, whiter look. It is added on a regular basis to help the silver dissolve from the anodes. Additions of Part B are made based on ampere hours. Additions are usually required every 500 ampere hours and the required addition will be based on the silver concentration. Typically a 1% to 2% daily addition of Part B will be required while plating. If the solution sits idle for a week or longer, a 2% by volume of Part B should be made.
Silver Conditioner	This is a liquid concentrate which is mixed 1part to 3 parts distilled water. The silver plated parts are dipped for 30 seconds at room temperature. Silver Conditioner leaves a non greasy film which is colorless and not apparent to the touch. It will not cause spotting or staining. It will not wipe off. The product should be maintained at a pH of 7 – 8.5 with sodium hydroxide and sulfuric acid (battery acid). After dipping, thoroughly rinse off in hot clean tap water.

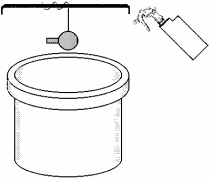
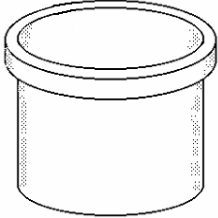

PROCEDURE	SETUP	OPERATING PARAMETERS	EQUIPMENT	SAFETY
1. SURFACE PREPARATION	Buff & Polish for a mirror finish. Bead Blast for a 'flat' finish.			
2. DEGREASING		140- 200 deg F No agitation 5 mins immersion  32 oz SP Degreaser 4 gal Distilled water	1 x 6 gal tank 1 x tank lid 1 x lid ring 1 x 200f heater 1 x 2lb SP Degreaser	
3. RINSE WITH DISTILLED WATER				
4. ACID ACTIVATE		30-60 sec dip ambient temp  1.5 gal D. Water  1.5 gal Battery Acid	1 x 3.5 gal tank + lid/ring  Battery Acid Distilled water	 Wear rubber gloves and goggles
5. WATER BREAK TEST	  <i>Oil/dirt film makes water bead up</i> <i>No oil/dirt film allows water to cover part</i>			
6. PRIMING	Steel, Pot Metal, Pewter = plate with FLASH COPPER 15 mins.  6a. RINSE	Copper, Brass, & Bronze = Plate directly		
7. SILVER PLATING		60-75 deg F (ambient) Air agitation Charcoal filter 9qts Dist. water 9qts Silver A 1 pint Part B 2 x silver anodes 1 amp per 16 sq" 2-6 volts Check pH 8.5 – 9.5	1 x 6 gal tank lid & ring Filter pump Charcoal filter Air pump Air line pH meter	 
Part B Additions	1% to 2% daily addition of Part B will be required while plating. If the solution sits idle for a week or longer, a 2% by volume of Part B should be made.			

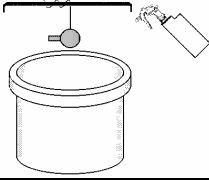
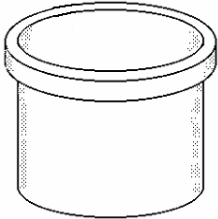
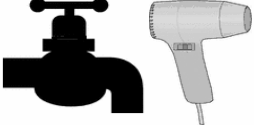
<p>8. RINSE IN DISTILLED WATER</p>	 <p><b>Rinse twice</b> 1<sup>st</sup> = spray above plating tank 2<sup>nd</sup> = immersion in distilled water</p>			
<p>9. ACID ACTIVATE</p> <p>same as step # 4</p>		<p>30-60 sec dip ambient temp</p> <p>1.5 gal D. Water</p> <p>1.5 gal Battery Acid</p>	<p>1 x 3.5 gal tank + lid/ring</p> <p>Battery Acid Distilled water</p>	 <p>Wear rubber gloves and goggles</p>
<p>10. RINSE IN DISTILLED WATER</p>	 <p><b>Rinse twice</b> 1<sup>st</sup> = spray above plating tank 2<sup>nd</sup> = immersion in distilled water</p>			
<p>11. Anti Tarnish Treatment</p>		<p>Add 1 qt Silver Conditioner to 3 qts distilled water. Ambient temp Dip 30 secs</p>	<p>1 x 3.5 gal tank + lid/ring</p> <p>1 x 1 qt Silver Conditioner</p>	
<p>12. HOT WATER RINSE &amp; DRY</p>				

NOTE Strong air agitation of both anode and workpiece are recommended.

PROBLEM	CAUSE	REMEDY
Parts not plating	Poor connections Silver content too low	Check all wiring Add 5% Part A
Parts turn dark grey or black	Power supply is reversed Current is too high	Positive must go to anode Reduce amperage
Parts are dark AND not plated	Current too low Not plated long enough	Increase amperage Increase plating time
Parts turn hazy, cloudy and dark	Current too high Temperature too high Organic contamination	Reduce current Reduce solution temperature Replace carbon filter in pump
Parts have a yellow or orange tint	Amperage too high PH too low No sulfuric passivation step	Lower amperage Raise pH After plating activate (see step 4)
Parts tarnish after plating	Silver Conditioner not applied	Dip in Silver Conditioner, Rinse in Distilled water and air dry
Silver precipitates out	pH too high	Lower pH
Metal concentration decreases Or Current drops off	Not adding enough Part B	Add Part B regularly Ensure air agitation is near anodes
Immersion plate	PH too low	Add KOH to raise pH to 8.8- 9.0

### Plating additives

**Silver Part A**= liquid concentrate and silver replenisher.

**Silver Part B** = liquid concentrate of electrolyte replenisher. Periodic adds over time based on ampere-hours. 1% to 2% daily addition of **Silver Part B** will be required while plating. If the solution sits idle for a week or longer, a 2% by volume of **Silver Part B** should be made.

### pH control for Silver solution

It is very important to operate the **Silver** at pH range 8.8 to 9.5. If pH is below 8.8, adjust with KOH (Potassium Hydroxide). If pH is over 9.5 adjust with 50% nitric acid. The pH must not go over 10.0

### Bath temperature must not exceed 120°F during operation.

**Replenishment of plating solution.** The Silver concentrate has a silver concentration of 4.0 oz/gallon. The working bath has a silver concentration of 2.0 - 2.4 oz/gallon.

**Cleaning Parts** It is extremely important to evaluate the cleaning in the existing line in order to have good performance for the **Caswell Silver** process.

**Note:** **Caswell Silver** contains silver in solution and therefore 42 Section 313 of the Federal Emergency Planning and Community Right-To-Know Act, which pertains to reporting, must be adhered to.

### **Caution**

**There is the possibility of chronic health effects with Caswell Silver. The absorption of silver compounds into the circulation and the deposition of reduced silver in various tissues of the body may result in the production of generalized grayish pigmentation of the skin and mucous membranes (argyria). Generalized argyria develops after 2 to 25 years of exposure. Ingestion is harmful and may cause death.**

## 24 ct GOLD TANK PLATING



Caswell 24ct Gold is a new type of alkaline cyanide free gold plating solution that will plate over nickel, sterling gold, gold, rhodium, copper, brass and bronze. It is preferred that copper alloys are given a strike coat of nickel. The system will provide uniform color consistency and even coverage.

Once the initial tank is setup, mark the liquid level on the side of the tank. Use this level to occasionally top up the level with distilled water. The solution is supplied ready for use and must not be diluted.

Stainless steel anodes are used, to reduce the cost of using large gold anodes. The investment in replacing solution is less expensive than purchasing a large gold anode, especially for the larger items, where a 1:1 anode to work piece ratio is preferred. If scrap gold (not gold plate) is used, the solution life will be extended.

It is important to ensure that the operating temperature of the solution is maintained at 140 deg f.

A ceramic heater is supplied.

This heater will NOT switch off, as it has no thermostat. As soon as the temperature has reached 140 deg F, switch it off. As most plating jobs only take 30 seconds, the liquid will not cool enough to effect plating performance.

Start plating at approx 2 volts and increase to 4 volts depending on the size of the part.

Air agitation will improve the plating evenness, however the system will plate well without it.







It is important when gold plating to realize what type of finish is required on the part. If a highly polished surface is required, the part must be buffed to a high shine before plating.

Do not dilute the solution. Top up to the original water line with distilled water to compensate for evaporation loss.

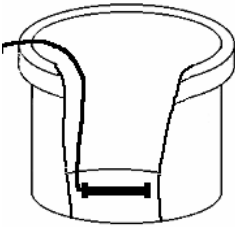
The anodes should be suspended in the tank in a similar manner to all other anode types, by snipping a small strip and using this as the hanger. After gold plating, rinse the part thoroughly in distilled water and dry completely with a hair drier or air-line.

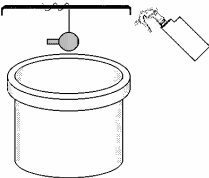
Lacquer or wax the part to maintain the shine. VHT Clear Lacquer provides an excellent thin coating for protection.

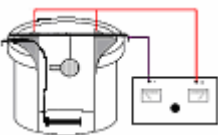
Worn areas on antiques etc. may be built up with gold before tank plating, by using the PlugNplate gold setup of *FastGOLD* and locally plating these defective areas. Clean off any smut before finally plating in the tank setup.

PROCEDURE	SETUP	OPERATING PARAMETERS	EQUIPMENT	SAFETY
1. SURFACE PREPARATION	Base metal <b>MUST</b> be nickel plated prior to gold plating. Buff & Polish for a mirror finish.			
2. DEGREASING		140- 200 <sup>o</sup> F No agitation 5 mins immersion  12 oz SP Degreaser 3 gal Distilled water	1 x Plastic tank 1 x tank lid (1 x lid ring) 1 x 200f heater 1 x 2lb SP Degreaser	Wear rubber gloves and goggles. Do not ingest 
3. RINSE IN DISTILLED WATER SPRAY				
4. WATER BREAK TEST	  <i>Oil/dirt film makes water bead up</i> <i>No oil/dirt film allows water to cover part</i>			
5. CALCULATE TOTAL SURFACE AREA AND PLATING TIME				
6. Tank Makeup		140 <sup>o</sup> F Agitation (pump)  Solution as supplied – do NOT dilute  0.005 amps per sq” 2-4 volts approx 30-60 seconds	1 x 300W Heater 1 x Thermostat 1 x plastic tank 1 x tank lid (1 x tank ring) 2 Stainless Anodes  Gold Solution	Wear rubber gloves and goggles. Do not ingest 
7. Replace lost water	After plating, top up the tank with DISTILLED water to the original waterline.			
8. Polish	Use a microfiber cloth etc to hand polish			
9. Surface protectant.	A clear lacquer such as VHT Clear Lacquer may be applied to protect the surface from physical damage. Automotive waxes may also be used.			

#### 24 ct GOLD PLATING TROUBLESHOOTING







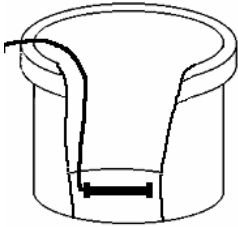

Problem	Cause	Remedy
Parts not plating	Poor connections	Check all wiring
Parts turn dark grey or black	Power supply is reversed. Current is too high	Positive must go to anode Reduce amperage
Parts turn hazy, cloudy or dark	Current is too high Temperature is too high Solution is used up	Reduce current Reduce solution temperature Discard and replace
Parts are dark and not plated	Current too low Not plated long enough Solution is old	Increase amperage Increase plating time Discard and replace solution
Parts are too 'rich' in gold color.	Amperage too high	Lower amperage Plate for a shorter time

## STAINLESS STEEL ACTIVATOR FOR GOLD (SSAG)

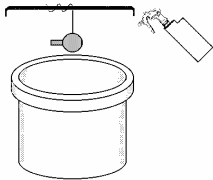

1. Fill a one quart or 1000 ml. beaker nearly full with Activator-SS.
2. Check solution temperature to assure it is between 80-100 degrees Fahrenheit.
3. Check connections from rectifier to anode and work to be sure the negative (-) and positive (+) wires are connected properly. Use Stainless Steel Anodes.  
The work should be charged negative (-), and the anode positive (+).
4. Turn rectifier on.
5. Activate at 6-8 volts for 45-60 seconds depending on size of part. Part should be completely clean prior to further plating.
6. Larger parts require slightly higher voltage, while smaller parts require lower voltage. If part shows any burning such as dark or grey deposits around the edges, you are burning the part and must lower the voltage.  
If part is not cleaning after two minutes, voltage is too low, therefore, increase voltage slightly.
7. After Activating, rinse part thoroughly in water and continue the plating process with Fastgold brush plating or Caswell Tank Plating Gold at 140 degrees Fahrenheit. Plate 15-30 seconds longer than normal. .
8. If you are not going to continue the plating process immediately, then dry the part thoroughly. When you continue the plating process, re-activate the part in SSAG to assure better adhesion.
9. Change solution when Activator-55 becomes inactive, reaches a pH higher than 2, or noticeably dirty. .

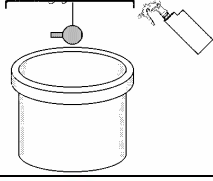
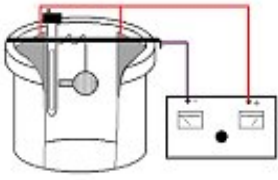
Activator-SSTM is a rugged solution and is designed to help assure long life. If a problem should arise that cannot be solved by any of the above recommendations, the bath may need to be replaced: Transfer to a D.O. T. approved container.

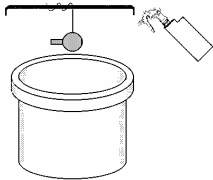
PROCEDURE	SETUP	OPERATING PARAMETERS	EQUIPMENT	SAFETY
1. SURFACE PREPARATION	All parts must be previously buffed and polished to reflect the required finish of the gold			
2. DEGREASING If required		140- 200 <sup>o</sup> F No agitation 5 mins immersion  12 oz SP Degreaser 3 gal Distilled water	1 x Plastic tank 1 x tank lid (1 x lid ring) 1 x 200f heater 1 x 2lb SP Degreaser	Wear rubber gloves and goggles. Do not ingest 
3. RINSE IN DISTILLED WATER SPRAY				
4. WATER BREAK TEST	  Oil/dirt film makes water bead up                      No oil/dirt film allows water to cover part			
5. SOAK ETCH		Ambient temp 70-80f 15 – 30 secs dip	Pickle # 4	Wear rubber gloves and goggles. Do not ingest 
6. RINSE IN DISTILLED WATER SPRAY				
7. PLATE		Ambient 70-80 deg F 2-4 volts  1 amp per 16 sq” No agitation required	1 x Plastic tank Stainless Steel Activator for Gold. Do not dilute	Wear rubber gloves and goggles. Do not ingest 
8. RINSE IN DISTILLED WATER SPRAY				
9. PLATE	Plate with whatever finish is required			



## THE LCD ANODIZING ALUMINUM SYSTEM

The process of anodizing is, chemically speaking, rather complicated, but in practice is extremely simple.

The process involves placing aluminum in an electrolyte, weak sulfuric acid, and passing a low voltage current through it. The aluminum part is connected to the positive (anode) side and the negative side is connected to a cathode made of lead.



This causes the aluminum to oxidize, similar to steel rusting, with the net result of a very hard, tough abrasion resistant protective coating being formed. An interesting 'quirk' of this process is that the film formed looks like honeycomb, and has 'tubes' growing up from the aluminum. These tubes conveniently allow color dyes to flow into them

For the technically inclined, the surface of the aluminum actually grows a layer of aluminum oxide on itself, which is then transformed into aluminum hydroxide (anodize) and finally hydroxide monohydrate. The whole anodize layer is non conductive. The hydroxide is microscopically porous which allows it to absorb dyes. This layer looks somewhat like a honeycomb, as can be seen from this photo, magnified some 40,000 times.

The 'barrier layer' at the base of the pores is thin enough to pass some current, even though the complete layer is non-conductive, so the honeycomb structure continues to grow, as long as current is flowing through the system. The acidity of the solution will also dissolve the anodize, so the latter is only true if dissolution is not faster than growth.

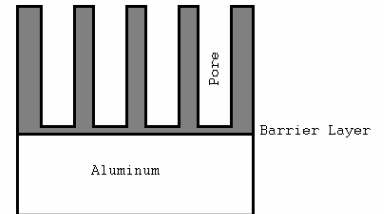
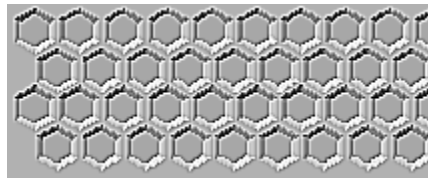

*Looking from above*

*Cross section*

Aluminum can be processed in a number of ways to achieve different effects. It may be highly polished to look like 'chrome', brushed with a wire wheel or Abrasive Wheel to provide a 'scratch brushed' finish, or even bead blasted to provide a 'satin' look. All of these processes would be done prior to anodizing, and the surface may, be sealed without dying.

All types of aluminum can be anodized using this process. Very little difference in performance has been noted using all of the more popular alloys.

The most exciting part of aluminum anodizing, is without doubt, experimenting with the amazing array of colors and effects one can produce, with a little practice and skill. The metal can be pretreated in a variety of ways, polished, scratch brushed etc., the anodize film grown, and then the colors applied prior to sealing the anodize surface, permanently locking the colors into the metal.

### Setting up the Anodizing Tank

#### Wiring up the parts.

Anodizing requires special attention to wiring up the parts, because only aluminum parts can be placed into the solution, so the actual wire, must be made of this, or titanium. Consequently, an aluminum wire also is anodized. If a connection is poor, then the anodize film grows on the wire, where it is touching the part, and an insulating barrier is formed, preventing further film growth.

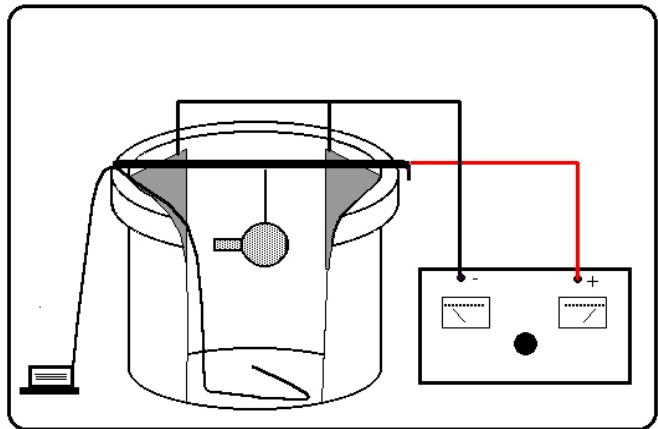

Thin aluminum wire may be obtained from almost any garden center/hardware shop. This is ideal for wiring small parts, as long as you make sure you secure the wire mechanically, either by wedging it into a hole or by tightening an aluminum bolt onto it, and into the work piece.

Ideally, the tank bar should also be made plastic. This will avoid corrosion problems and any shorting out due to mists settling on a metal tank bar. A solid bar of aluminum is included, and for the engineering inclined, this could be drilled with holes to accommodate the wire or needle, which could be secured with small aluminum or lead wedges tapped into the block to trap the wire.

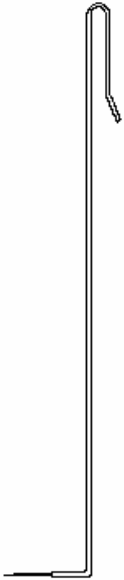

An alternative technique to wire is to use knitting needles. By removing the top of the needle and bending it into the shape needed, it can be forced into a slightly smaller hole, using the needle's tapered point as a wedge.

Aluminum knitting needles are usually anodized, and as this is an insulator, the anodize must be removed, either by sandblasting, abrading with emery paper, or stripping in the anodize stripper. If stripping, leave the needle in the stripper until all the color has gone, usually about 3 minutes. Some needles are coated with lacquer, so you may have to abrade this off.

If you decide to re-use these, you **MUST** strip off the anodize film every time prior to usage.

Our preferred material is soft aluminum wire.

There is a host of different types of Titanium grips and racking clips available. Titanium is not anodized in the process, saving you the job of stripping your racks after each operation. Titanium is also much harder and stronger than aluminum.

Servi-Sure Inc are suppliers of these racks. [www.servisure.com](http://www.servisure.com)

2020 W. Rascher Ave., Chicago, IL 60625 Phone: (773) 271-5900, Fax: (773) 271-3777

Email: [racks@servisure.com](mailto:racks@servisure.com)

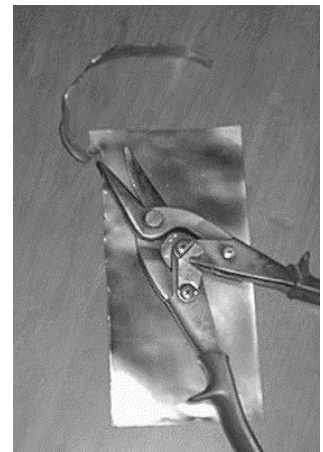

### Installing the GP Plates (Cathodes)

The anodizing system uses 2 GP plates 8" x 8" as cathodes. (The actual part being anodized becomes the anode). To install these into the tank, see page 11 & 12 for anode/cathode installation procedures.

The GP Plates should be occasionally cleaned using wire wool or Scotchbrite type material.

Remove the plates from the solution when not in use.

## CONTROLLING THE POWER for LCD anodizing

### The Power Supply and Power Requirements

Unlike plating, anodizing has the peculiarity of becoming an insulator to itself, cutting off power and stopping further growth of the film. The thicker the film, the more insulated the part becomes from the power supply. There comes a point when a Peak Anodic Resistance (PAR) is reached, when the film will grow no more, and if power is kept being applied, it actually erodes away the film. PAR is quite visible on a power supply, because the amperage needle drops off. It is therefore useful to install some type of ammeter into your system, so you can see when you reach PAR. The optimum current requirement is 4.5 amps per sq foot, or 30 milliamps per sq inch.

**Battery chargers** do a barely passable job on anodizing, and the current still needs to be controlled.

There are some major misconceptions about using battery chargers as power sources. Battery chargers are rated for driving a partially discharged battery, not a grounded load like anodizing or plating. As an example, the voltage was measured and current of a charger under load. This unit was rated for 12V at 10A, when loaded the results were as follows:

At 0 A	(no load)	V=13.4V
At 3.66 A	(3 Ω)	V=11 V
At 5.35 A	(2 Ω)	V=10.7 V

A 10 amp load wasn't tested as it would overheat the charger and open its thermal circuit breaker if operated for any realistic length of time. If this unit were rated as a transformer isolated unregulated power supply, using a full wave rectifier (which is what it is) the rating would be 10.8 V at 5 A. Larger or smaller chargers will scale accordingly.

Besides not putting out the voltage and current that you think you are getting, battery chargers also have no effective means to reduce the voltage and current provided to the load.

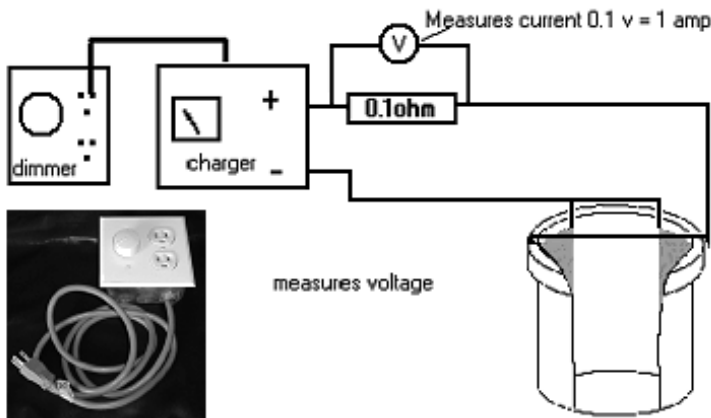

You can compensate for the first problem by de-rating the battery charger as discussed above, and there is something you can do about the control problem. A perfectly simple way to solve the control problem is to use an ordinary 600 W lamp dimmer to control the input to the charger. This is shown in Figure 6. A charger is a transformer load, not a motor load. The dimmer can power a transformer as easily as it can power a light bulb. The resolution you can actually get isn't great, but it is better than you can get using any reasonable number of power resistors or light bulbs to control the current.

Figure 6. A Variable Voltage Battery Charger Power Supply





### Batteries.

We do not recommend the use of batteries because of the difficulty in controlling them.

### Constant Current Power Supplies

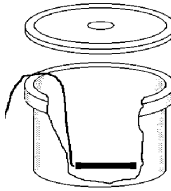
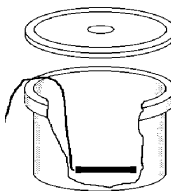
Rectifiers are the ultimate in anodizing. Variable controls, voltage and amperes dials, allow you to fine tune your anodizing efforts. This can be especially useful when dying, as the minor variations can effect pore size of the anodize, which may interfere with the acceptance of the dye. Our new 3amp 'CONSTANT CURRENT' power supply is the ultimate in anodizing. A 5 and 20 amp model is also available.

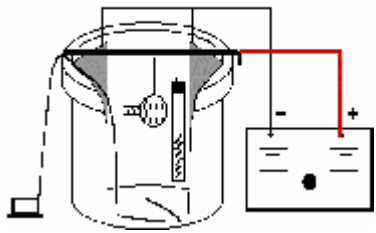

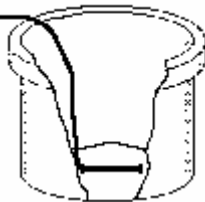
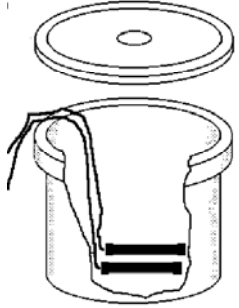
PROCEDURE	SETUP	OPERATING PARAMETERS	EQUIPMENT	SAFETY
1. SURFACE PREPARATION	Buff & Polish for a mirror finish. Bead Blast for a 'flat' finish. Nylon Abrasive wheel buff for a 'scratched brush' look.			
2. DEGREASING		140- 200 deg F No agitation 5 mins immersion  16 oz SP Degreaser 4 gal Distilled water	1 x 5 gal tank 1 x tank lid 1 x lid ring 1 x 300W Heater 1 x 2lb SP Degreaser	
1. RINSE IN DISTILLED WATER SPRAY 2. WATER BREAK TEST				
3. ALUMINUM DE-OXIDIZER		110 deg F No agitation 3 mins immersion  4 gal Distilled water 2 x 1 qt De-Oxidizer	1 x 300W Heater 1 x Thermostat 1 x 5 gal tank 1 x tank lid 1 x tank ring 2 x 1qt De-Ox	 gloves and goggles
RINSE IN DISTILLED WATER SPRAY				
4. ANODIZING TANK		Ambient temp 60-75F Current at 4.5 amps per sq ft for 90 mins. Agitation 3 gals distilled water 1 gal battery acid (add acid to water) 2 tsp Mist Suppressant	1 x 5 gal tank 1 x tank lid 1 x tank ring 2 x GP Plates 1 x Filter pump 1 x 200w adjustable heater Mist Suppressant	 gloves and goggles
RINSE IN DISTILLED WATER SPRAY				
5. DYE TANK		140 deg F No agitation 15 mins immersion  2 gal Distilled water 1 x 4oz bottle of Caswell dye Warm water to 180 f before adding dye	1 x 5 gal tank 1 x lid 1 x ring 1 x 300W Heater 1 x Thermostat	
RINSE IN DISTILLED WATER SPRAY				
6. SEALANT		210 deg F No agitation 15 mins immersion  4 gals Distilled water 4 oz Anodizing Sealant  Use mist balls and the lid to retain heat and speed heating. In extreme cold, wrap sides of tank with bubble-wrap & duct tape.	1 x 5 gal tank 1 x lid 1 x ring 2 x 300W heaters Mist balls 1 x 1lb Anodizing Sealant	
RINSE IN DISTILLED WATER SPRAY				

## Aluminum De-Oxidizer & De Smut.

Aluminum De-oxidizer is a concentrated, easy to use liquid material designed to deoxidize and de-smut aluminum prior to anodizing and chromating. Aluminum De-oxidizer is non-chromated, yet offers performance comparable to or better than most chromate bearing products. The product is especially useful on certain types of aluminum alloys found on Japanese motorcycles, which have a certain amount of zinc in them. The presence of zinc makes the casting smut as soon as it enters the anodizing tank. Pre-dipping with Aluminum De-oxidizer reduces this problem.

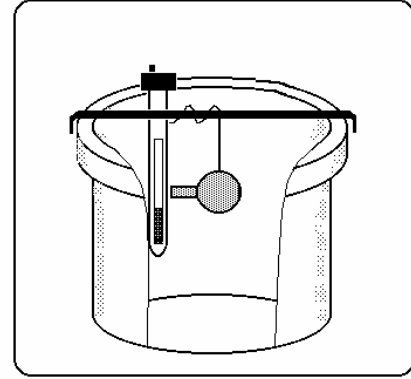

### PRODUCT FEATURES

No chromate disposal problems.

### EQUIPMENT

Tank: HDPE Plastic tanks

Agitation: Continuous air agitation is recommended to increase effectiveness.

### OPERATING PARAMETERS

Concentration: Mix 1 qt (1 liter) of Aluminum De-oxidizer with 2 gallons water

Temperature: 70-110°F Optimum 100 deg f

Immersion time: 1-3 minutes

Water: De-ionized or distilled



### SOLUTION MAKEUP

Before making up or replenishing the working solution, refer to the Material Safety Data Sheet for protective safe handling measures.

1. Fill tank 2/3 full of water.
2. Add required amount of Aluminum De-oxidizer to the water with mild agitation.
3. Add water to operating level and mix again.
4. 110 deg F

To prevent excessive heat generation and spattering, never add water to Aluminum De-oxidizer. Always add Aluminum De-oxidizer to water. Add in small amounts over the entire surface of the solution with mild agitation.

Dip the parts into the solution for 1-3 minutes, rinse in fresh water, then immediately proceed to anodize the part.

### Operating the Anodizing System.

1. **Check the part for cleanliness.** After thoroughly preparing the part, by bead blasting, polishing etc. ensure it is completely degreased by using the 'water break test'. Simply run water over the part, if the water sheets evenly, then the part is clean. If it 'balls up' or spots, then it needs further cleaning. At this point, the part should already be wired up to the tank bar. This will prevent you from handling it. **DO NOT TOUCH THE PART FROM THIS POINT UNTIL THE PROCESS IS COMPLETE.**
2. **Caustic Etch.** Dip, for a few seconds only, into a room temperature solution of Anodize Stripper, as the etching action will dull the finish slightly. To maintain a bright finish, you may omit this step, however, the part **MUST** pass the 'water break test'. Rinse the part.
3. **Anodizing De-Oxidizer** Dip the part for 1-3 minutes into the pre-mixed solution at 100 deg F. See the section on Aluminum De-oxidizer.
4. **Rinse**, thoroughly in fresh water. Agitate the part, and if necessary, spray with water to rinse chemical from hard to reach areas. A sprayer attached to a faucet is a great idea.
5. **Anodizing the Part.** Place the part into the tank, and connect the tank bar to the positive side of your power supply. Make sure the negative wire is connected to the GP Plates (cathodes). Switch on the power.



6. **General Duration of Anodizing.**

This is totally dependant on the part reaching PAR, Peak Anodic Resistance) 1-3 hours  
Remove the part from the tank and rinse off thoroughly in distilled water.

7. **Acid Neutralizer.** Make up a tank of 1 gal distilled water and 1/2 lb baking soda, as your neutralizer tank. Before proceeding to dying, the part must be completely ridden of acid; otherwise, this will cause you problems. Acid dragged from the anodizing tank into the dye tank will cause streaking and blemishes. It will also eventually alter the dye's color. After neutralizing, rinse in fresh or distilled water.
8. **Dying.** (If a clear anodize is required, skip this part). It is important to try to dye the part as quickly as possible after growing the anodize film, otherwise the pores will begin to close up, and the dye will not be able to penetrate quite so effectively. Dying techniques are covered in a separate section. Rinse in fresh water.
9. **Fixing (or sealing)** Using a plastic tank supplied with the kit, place 1 or 2 gals of water, depending on what will cover the part, and add 1 oz per gallon of ANODIZING SEALANT POWDER, and bring to the boil using the non adjustable ceramic heater. Then place the anodized part into the tank, using the tank bar as the suspension support. Boil for 2-3 minutes per 0.10 mil oxide coating thickness. 24 microns = 1 mil Wipe the parts dry and immediately apply a mineral oil (WD40 etc) with a soft cloth. Alternatively, you could use ANODIZING SEALANT LT which is a liquid. Add to distilled water at the rate of 2 fl oz per gallon. Warm the liquid to approx 85-95 degrees and immerse the part for 10 minutes. Anodizing Sealant LT may slightly effect the color of some dyes, but this is offset usually by the simpler technique.
10. **Cure.** Allow the part to cure in an ambient, dry area for 24 – 48 hours to obtain its final hardness
11. **Polishing.** You may polish the part using a loose cotton buffing wheel and either a white or blue buffing compound. Be sure to take care, the anodize film is not very thick. You could damage it.
12. We have included 5 pieces of 6061 aluminum strips 10” long for practicing on. Please use these to go through all the processes. Immerse the strip 8” into the solution, so that your contact point is NOT immersed. This will reduce the problems caused by poor connections. You will have 16 sq inches in immersion, which requires 1 amp to anodize it. If you use the same sized part each time as you learn how to do this, it eliminates several variables that can sometimes affect the end result, making it difficult for us to troubleshoot.
13. The longer strip of aluminum supplied in the kit is for your tank bar. Use aluminum wire or knitting needles to hang the parts from the tank bar.

## Dying the Anodize

The dying of anodized aluminum is probably one area where artistic creativity can really come to the fore. Limited only by your imagination, parts can be dyed in many ways and colors, to create amazing results. The application of the dye can be done in several ways: simple immersion for a single color, multi immersions for two or three tone effects, air brush painting, silk screen, splash dying etc. etc.

Here, we hope to address all of these techniques, but your best way of getting the most from this process is to EXPERIMENT!

Caswell Inc now carries a range of professional dyes. For a color sample, please visit our web site @ <http://www.caswellplating.com/kits/anodizedye.htm>

These dyes can be mixed together to create a host of different colors. The dyes are in concentrated liquid form, a 4oz bottle makes up 2 gals of ready to use dye. To make up different colors, we suggest that you make up the colors to the correct dilution first, then take a quantity of each dye and blend them together.

A color wheel is supplied with all anodizing kits. The use of a color wheel will give you a good concept of what to expect when dying, however, **it does not represent our dyes specifically.**

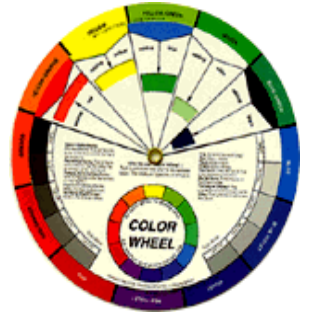

### What Does the Color Wheel Do?

The Color Wheel shows how the three primary or parent colors (the only colors that cannot be made by mixing two others) relate to each other. The wheel clearly illustrates the results of color mixing. For example, equal amounts of two primary colors (red, yellow, or blue) create secondary colors (orange, green, or purple).



Yellow + Red = Orange



Blue + Yellow = Green

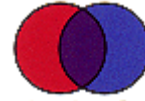

Red + Blue = Violet

Anodizing dyes are transparent, so this means you can 'overlap' colors, just as in the diagram above. The dye colors also mix well, which allows plenty of variety in 'mix 'n match' dying. When over-dying, consideration must be given to the color wheel, red and yellow = orange, blue and yellow = green etc. These colors are adjacent to each other on the wheel. However, if you try to dye across the wheel, eg: yellow & violet, or blue and orange etc, you will get only shades of brown. Dying green over red gives you black or brown.

Dyes are designed to operated at 140 deg F, however, we have found most of our dye will work at room temperature, providing you are using our new parameters for power and attaining PAR. Some variation in shades may occur.

**A note on RED DYES.**

These can be the most troublesome of the dyes

Dye pH must be between 5 to 6

0.5mil - 0.7 mil film thickness of anodize film required

Seal must be at a boil @ 1oz per gal with a pH 5.5 - 6

If not at a boil, or concentrate is weak & pH too high it makes red bleed a lot.

If the Sealant is murky = pH too high. if clear & green = OK

Other colors will not do this, so comparisons are worthless.





may use a cotton swab, Q-tip, or a spray bottle. The spray bottle will help to give a smoother gradient. Be sure to thoroughly rinse all parts after they have been bleached to prevent contamination of your dye.

The darker color of the fade. Using the same method as before, submerge the part in the dye bath, continually dunking the part in and out to keep it in motion. Again, as you see the fade developing you may want to rinse the part in cold water to ensure that the dye is being absorbed and not just sitting on the surface. Once the desired fade is achieved, seal the parts as you normally would.

Although the above method only describes a two-color fade, it can easily be used to achieve a fade with 3, 4, or more colors. To achieve multi color fades, you should start in the center of the part, working your way outwards. After each color, remove the unwanted colors with bleach and rinse thoroughly between each step to avoid dye contamination.

Below is a picture of the Spyder paintball marker faded from blue to silver using this method. Notice the green cylinder above the gun. This was the original color of the gun before re-anodizing. In the 2 pictures, both sides of the part can be seen, clearly showing the smoothness of the gradient, or fade, thus accomplishing the original goal of a quality fade anodized finish with minimal extra investments in equipment.



Although this method does require a person to be present during the entire 10-20 minutes necessary to complete the dyeing, there is minimal added equipment or chemical cost. However, there is virtually no limit to the possibility of color combinations achievable with this method. When compared to other methods, I find this the preferred method for short-runs and completely custom anodizing for beginners and pros alike.

## COLOR MIXING

You have some choices when it comes to creating new colors.

- **A. You can premix the dyes.** This involves some experimentation to get exactly the right color.
- **B. You can over-dye.** Starting with the lightest color, simply dip the part in, rinse off, then dip into the next color, and so on. Using this technique, you can easily see exactly what is happening, and you don't waste your original colors by premixing.
- **C. Toning a dye color.** Various shades can be created by dipping the colored anodize into a black dye.
- **D. Shades of color.** The duration of dipping time will lighten or darken the overall color of the dye.

## PREFERED DYING TECHNIQUE

This dying technique is created by simply siphoning the dye from a higher holding tank, into a lower tank which has the part suspended in it. As the liquid level rises, the dye will fade dye the part dependent on liquid level rise and duration.

You need two plastic containers, and a length of tubing.

Set one container on a bench, and pour in to it the heated dye. It is probably best to over heat the solution by 10-20 degrees so that the 140 f temp is maintained in the lower tank.

Suspend the part into the empty tank, checking the relative height, and bearing in mind at what point the level will rise to. Some practice is required to perfect this process.

## COLOR APPLICATION

There are an almost infinite number of ways you can apply dye to anodized surfaces.

- Immersion.
  - Full immersion to produce one solid color
  - Partial Immersion to produce two or more colors
  - Over dying by immersion.

- Direct Application

- Air Brush (see right)
- Paint Brush
- Syringe
- Eye Dropper
- Sponge
- Splash or spill over
- Silk Screen
- The dye may need to be thickened. This is accomplished using the following materials:

Water 1000 parts  
Corn Starch 75 parts  
Tapioca Starch 25 parts  
Gum Tragacanth 225 parts

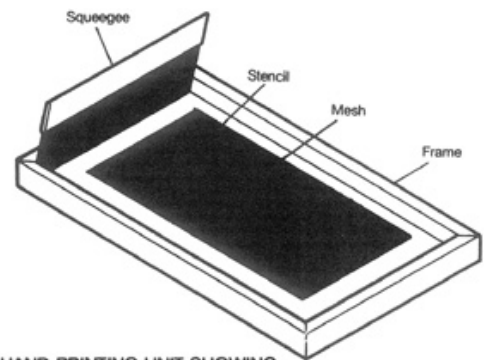

HAND PRINTING UNIT SHOWING  
4 BASIC COMPONENTS OF SCREEN PRINTING.

Add this mix @ 20% to 80% of the dye depending on the consistency required. There is a huge potential for silk screen work in the decoration of aluminum for road vehicles. In particular, the motorcycle and Hot Rod enthusiasts would love to see the large areas of aluminum, such as side covers, with more permanent decoration. By using a silk screen process, and starting with the lighter colors, several colors could be screened over the aluminum, to create full color logos etc. Pastel dyes could be used as a background color. A good example would be a side cover from a Harley motorcycle. Dip it in the gold dye first, then screen on the orange of the Harley logo, and finally screen on the black element of the logo. The part would need to be set in a jig of some sort, to ensure the logo colors are printed in the correct places. A little 'Imaginering' and a small production run could easily be set up.

## MASKING OFF

There may be areas where you want the original color of the metal to show through, yet total immersion would spoil the effect, or you may want to create patterns in the over dye or subsequent colors. To prevent dye from affecting these areas, a

number of 'masks' can be used, such as: masking tape, Avery Labels, clear contact paper, rubber cement, grease pencils, etc. Liquid masks can also be applied using a simple silk-screen process. Grease pencils will be removed in warm water. Check the melting point of the pencil.

## REMOVING DYE

You may find that a mistake has been made on your work-piece, perhaps the color is wrong, whatever the reason, you have to remove some, or all, of the dye. As long as the part has NOT been sealed, most dyes will easily be removed by immersing in household bleach. We've found that our black dye (the most dense color) whites out in about 1 minute with a splash of bleach. Rinse the part thoroughly afterwards in room temperature water (not hot, or you will start to seal the anodized surface). You may apply the bleach with a brush, or a cotton swab, or you may even fully immerse the part.

**MAKE SURE YOU DO NOT ACCIDENTALLY DROP BLEACH INTO ACID, (e.g. the anodize tank), AS THIS CREATES CHLORINE GAS DANGEROUS FUMES!**

If the part has been sealed, then you can immerse it in ANODIZE STRIPPER to remove all the dye along with the anodize film. Of course, after doing so, you'll have to re-anodize the part.

## SEALING THE ANODIZE WITH ANODIZING SEALANT

High Temperature Sealant. (Do not confuse this with room temperature LT system, which may allow some colors to leach out slightly.)

A plastic tank and a special ceramic heater (right) are supplied for sealing. This heater will boil the solution. **DO NOT LEAVE UNATTENDED** or the solution will boil away and the tank may ignite.

Do NOT use aluminum or any metal container, as it causes problems.

Always use distilled water, as ordinary water may leave mineral deposits on/in the film.

Anodizing Sealant is a nickel acetate compound for sealing anodic coatings on aluminum. It is a fine flowing greenish powder, readily soluble in water and specifically formulated with a pH regulator and an agent to help minimize smut. Anodizing Sealant is suitable for clear anodize and offers increased weather and light-fastness on coatings dyed with aluminum dyes.



## OPERATING PARAMETERS

Make up a solution of : 1 oz per Anodizing Sealant to 1 gal of distilled water - or 7.5 grams per liter

Time: 5 to 30 mins depending on anodize thickness (2-3 minutes per 0.10 mil. oxide coating thickness) 24 microns = 1 mil.

Temperature: 202-210°F      pH: 5.5 to 6.0      Water: De-ionized or Distilled water

## CONDITIONS FOR USING ANODIZING SEALANT

**Tank:** Sealant solution should be contained in a plastic tank.

**pH:** pH adjustments will not be necessary unless acidic or alkaline compounds are carried over into this sealing bath. Add acetic acid (to lower pH) or ammonia (to increase pH). Acetic acid is difficult to come by, and it is preferable to discard the bath, especially as it has a limited shelf life anyway. White vinegar is a good substitute.

**Rinse:** Before sealing, a LIGHT rinse is necessary to remove any foreign substances. After sealing, the work should be thoroughly rinsed at once, as is normal in nickel acetate sealing, before it is dried.

**Filtration** Filtration clears the bath of precipitates with interfering action. Filter through coffee filters after each use.

**Maintenance.** Bath life is 14-60 days dependent upon operating conditions and bath upkeep.

## BATH TURBIDITY

Freshly prepared nickel acetate sealant baths are clear green solutions. In use they become contaminated by precipitates and grow cloudy. If not removed, these contaminants can form deposits on the sealed surface. The effect can be due to the following: High pH (at pH values above 6.0, nickel acetate may be converted into soluble nickel hydroxide), hard water and trapped impurities.

The following measure can be taken to minimize this affect: Maintain pH value of  $5.7 \pm 0.3$ , through rinsing of anodized, dye or un-dyed work prior to sealing to prevent possible introduction of contaminants and filtration to clarify the bath and to prevent surface deposit formation

### ANODIZING SEALANT LT

Here is a great new product which eliminates the need for boiling to seal the anodize.

This remarkable material seals in only 5-10 minutes. Simply add 2 fl oz per gallon of distilled lukewarm water.

It works by penetrating the pores of the anodized surface and through a precipitation mechanism plugs the pores to provide an anodic film with improved corrosion resistance.

Seals at only 90°F. Can be used on clear, electrolytically colored and most dyed finishes.

### OPERATING PARAMETERS

Concentration:	1.7%-2.0% by volume	Time of Immersion:	5 to 10 minutes
Temperature:	88°-92°F	pH:	5.8-6.1
Fluoride Concentration:	550-650 ppm		

### CONDITIONS FOR USING ANODIZING SEALANT LT

**Tank:** Stainless steel or lined steel, or plastic.

**Water:** Deionized. Distilled **Heat:** Use Aquarium heaters.

**pH:** Lower with 10% sulfuric acid. Raise with small, slow additions of 50% sodium hydroxide. Do not allow the pH electrode to sit in the sample for any length of time. Fluorides in the bath will cause damage.

**Rinses:** Rinse Thoroughly prior to sealing. Use good quality water and overflow at adequate rate to maintain low icon concentrations. A clean high quality rinse after sealing will eliminate dry-on stains, water spotting and powdering.

**Agitation:** Agitation is needed for make-up and additions. No agitation is required for normal operation.

**Filtration:** As Anodizing Sealant LT bath ages, a small amount of particulate matter will form on the work if not removed by filtration. The seal tank should be filtered 2-3 times per week, using a coffee filter. Lower the pH to 4.5-4.8 before filtering the seal bath.

**SEAL TEST.** Parts sealed with Anodizing Sealant LT will pass a dye stain test immediately after drying, but require at least 6 hours to pass the modified dye stain test and 24 hours to pass the acid dissolution test (ADT). Full curing occurs in approximately 30 days. This curing can be accelerated by a 150°F DI water rinse for 5 minutes and will pass the ADT once the work piece dries.

### BEHAVIOR OF DYEING IN LOW TEMPERATURE SEALING

Field experience has shown that the use of a fluoride sealant can lead to leaching of the dyed parts during the sealing process. Anodizing Sealant LT compatibility with aluminum dyes should be confirmed by users owns test.

### TYPICAL PROCESS CYCLE

1. Clean SP Degreaser.
2. Spray Rinse
3. Dip Rinse
4. Deox/ desmutt using deoxidizer.
5. Spray Rinse
6. Anodize
7. Spray Rinse
8. Dip Rinse
9. Dye (Rinse)
10. Spray Rinse
11. Seal in Anodizing Sealant LT
12. Warm water rinse at 150°F

**STRIPPING THE ANODIZE FILM**

Mix up a solution of 4-6oz of Anodize & Chrome Stripper with 1 gal of water. Add the powder slowly to the water.

Dip the anodized part into the solution for between 20 seconds and 10 minutes, depending on the thickness of the existing anodize film.

Rinse off the part thoroughly in fresh water.

**TESTING FOR ANODIZE FILM CONTINUITY** (see overleaf) and if present re-immense.

Ideally, the solution should be at approx 70 deg F plus. The hotter the solution, the more rapidly the anodize film will be stripped. Solution temperature range is 70-150 deg f.

Use only plastic vessels, not aluminum, as this material is extremely corrosive to this metal.



**TESTING FOR ANODIZE FILM CONTINUITY**

Anodize film is non-conductive, whereas the actual aluminum is conductive. It is therefore relatively easy, using a multimeter, to determine if we indeed have grown an anodize film. Set any multimeter to the 1000 ohm setting.

Place the black and red probes on the aluminum in different places. The needle on the multimeter dial will swing over if there is NO anodize film. If you have grown an adequate film, then the multimeter will not register at all.

The work must be perfectly dry to do this test.

Test does not show ADEQUATE GROWTH, but only that there is SOME growth of film.

**Some Interesting Points about Anodized Aluminum.**

Anodized aluminum has a very durable surface that is unaffected by weather and many chemicals. The surface will resist high temperatures, even a blowtorch, for short periods. Many other types of dye may be used with varying effects, fabric dye, leather dye, water-based ink, felt tip pens etc.

Anodized films are usually measured by their intended operation:

Interior or unexposed articles	0.1 - 0.2 mil (mil = 1/1000")
Auto Trim	0.2 - 0.4 mil
Architectural or construction	0.8 - 1.0 mil

Once a part has been anodized, it cannot be reshaped, and any great degree of flexing will cause the anodize film to crack.

Sharp edges can create problems, because the anodize pores grow out at right angles to the metal. On the example here, the corner area is almost completely void of pores. This will show up when dyeing.

MIL SPEC A-8625F calls for a 1/32" minimum radius on corners, when applying a 1 mil anodize film.

Consideration needs to be given to this phenomenon, and sharp edges should be rounded over.

Pore diameter and barrier film thickness will vary depending on the voltage and the electrolyte temperature. Different alloys will also have different effects. Pore size is related to current density, higher volts means smaller pores. Generally speaking, the larger the pore, the easier the dye will take.

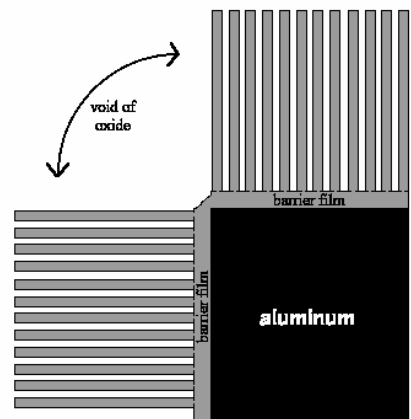

## TROUBLESHOOTING ANODIZING

FAULT	PROBABLE CAUSE	REMEDY
Decrease in depth of color	Bath contamination Dye used up	Improve rinsing Extend dying time Replace bath
Color depth changes in a production run	Anodizing film is inconsistent	Improve conditions to ensure constant procedure
Color differences	Irregular current in anodizing procedure Different alloys	Clean contacts Dye only similar alloys
Darker edges	Irregular current density and heat building up film	Reduce current/heat Lower dye temp and dye for longer period
Large cloudy areas	Anodizing temp not uniform	Increase agitation
Pale spots	Oily Uneven wetting of the parts when dying impurities Local overheating by polishing Gas bubbles on anodize pores	Add 2 drops liquid detergent Immerse in the wet state only. Agitate the parts in the dye bath. Re-anodize -briefly  Agitate parts. Increase agitation.
Dark Spots	Over heavy dyeing, superficially attached particles	Reduce dying temp & extend dying time.  Clarify dye bath by filtering.
Dull &/or chalky dye (probably won't wipe from surface.	Inadequate anodize, too soft. Current free suspension in anodize. Coating attacked by low anodize bath pH.	Reduce anodize temp/time &/or acid concentration. After switching off current, remove parts & rinse off. Increase PH to 4.
Opaque & dull coating, removed by wiping.	Excess of hydrolyzed aluminum.	Replace dye bath. Acid dip part prior to dying to dissolve & clear aluminum.
Surface pitting & soft coating	Part too close to the cathode	Increase tank size &/or move part further away

### ANALYZING DYING PROBLEMS

#### Questions to ask

1. What dye was used?
2. What was dye-bath concentration, pH and temperature?
3. What was the oxide coating thickness?
4. How long was the part dyed?
5. What sealant was used? At what concentration, temperature, pH and time?
6. Were the parts cleaned, etched and deoxidized prior to anodizing?
7. Does the faded part have exposure to light from a window?
8. Does the part get hot?

#### Main Reasons parts fade:

1. Wrong type of dye used.
  2. Parts not dyed long enough.
  3. Oxide coating too thin.
  4. Poor sealing.
  5. Parts exposed to high temperatures.
  6. Interior parts were dyed with wrong type of dye and placed by a window.
- 99% of the time, the cause is dye time (too short), poor sealing and too thin oxide coating.
- Please remember, just because a dye may have a good rating for light fastness, it does not mean that it will have an unlimited life expectancy.





## BRUSH PLATING with PlugNPlate

The following solutions are available for use with PlugNPlate adapters

Solution	Plates onto:	Soln. Size	Wand	Wand Color	Adapter Output in volts
Nickel		8oz	Stainless	silver	4.5 – 6
Flash Copper	Pot metal, steel, copper, bronze, brass, tin, pewter	8oz	Copper	brown	4.5 – 6
Copy Chrome	Steel, copper, bronze, brass, tin	8oz	Stainless	silver	4.5 – 6
Brass	Steel, copper, bronze, brass, tin	4oz	Brass	gold	4.5 – 12
Gold	Nickel, silver, copper	4oz	Stainless	silver	4.5 – 6
Silver	Nickel, copper, brass, bronze, tin	4oz	Stainless	silver	1.7 – 3
Tin	Steel, nickel, copper, brass	8oz	Tin	Silver + inserted strip	4.5 – 6
Bronze	Steel, nickel, copper, brass	8oz	Stainless	Silver	4.5-6
Black Krome	Steel, nickel, copper, brass, Stainless Steel, Tin	8oz	Stainless	Silver	4.5-6

Gold, silver and brass are also supplied in 1-pint bottles. Nickel, Copy Chrome and Copper should be purchased from our standard price list as 1 gal ‘crystal’ packs. The same solution for tank plating is used for brush plating. Larger quantities of Brass may be purchased by the liter.

### General Setup

The PlugNPlate power supply for Brush Plating has two terminals. The red plug or the alligator clip fits into the open end of the plating wand. Sometimes the red plug may be a little loose, but this can easily be tightened by placing the plug into the wand, then gently squeezing the wand case with a pair of pliers, until the fit is tighter.

The black alligator clip is attached to the work-piece. The blade of the wand is wrapped with the bandage in such a way that no metal is showing, as if the bandage was being applied to a cut in the tip of a finger. The end of the bandage should be secured by a rubber band or a small piece of sticky tape. Plug the PlugNPlate power supply into a 110-volt power outlet. Make sure the two terminals are not touching, as this will short out the unit, causing irreparable damage.

Occasionally, oxides will build up on the plating wand blade. These should be removed with a wire brush, steel wool or emery paper.

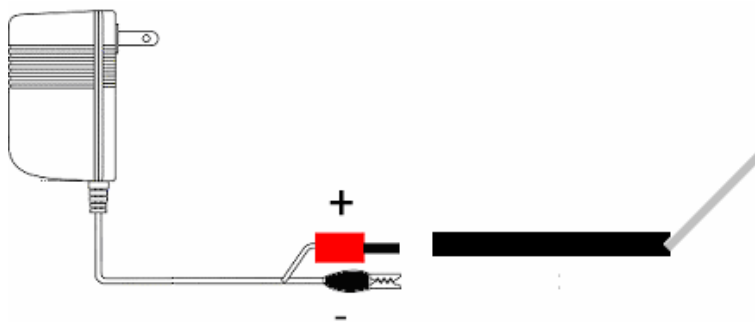

### Additional Plating Wands

The PlugNplate workshop has some detailing wands. These have small marker pen nibs; chisel, fine point, and bullet. To use these nibs, connect the wand to the power pack in the normal manner, then dip the nib into the solution until it is well soaked, then use in the normal manner. These nibs do NOT require a bandage.

### Surface preparation

All surfaces must be highly polished and thoroughly cleaned, with no corrosion.

The use of a mild abrasive cleaner/polish such as Caswell Inc. Blue Begone Prod # BLUBG will greatly assist in cleaning. Do not touch the cleaned part with your fingers after cleaning.

### **Brush Plating Procedure**

Pour a small quantity of plating solution into an eggcup sized plastic container. (The actual lid of the plating solution will do). Firstly, dip the clean wand into the entire bottle. Hold onto the bottle, otherwise it WILL tip over. Let the solution thoroughly soak into the bandage. This should take about 30 seconds.

Proceed to brush plate the area to be treated, using soft strokes, (somewhat like stroking a cat). Do not stop in any one place, otherwise 'burning' will occur. You should plate at about 1 sq. inch per minute. After a few seconds, you will find that the plating is no longer proceeding as quickly. This is because all of the metal has been used up from the solution contained on the wand. Dip the wand in the smaller amount of solution (in the eggcup), and NOT in the main bottle. Harmful oxides build up during brush plating, and repeated dipping of the contaminated wand will spoil many of the solutions. You may repeatedly dip your wand into the smaller amount of solution.

If the plating has black streaks, speed up the wand action and press down harder. A few more passes over the blackened area will clean it up. This is especially prevalent with silver plating.

### **BRUSH PLATING WITH COPY CHROME**

Copy Chrome is a nickel alloy, harder than nickel and with a blue tint like chrome. It should be plated directly to the metal, and does not need an underlying layer of nickel plate like a normal chrome plate. Because of its extra hardness, it is important to ensure the part is highly polished prior to plating, as this finish is harder to buff than nickel.

Also plates onto Aluminum, lead, pewter, stainless if the base metal has been primed with its respective priming system.

### **BRUSH PLATING WITH SILVER**

Silver requires a lower voltage than any other plating process. The plate will tarnish very easily, even during the plating process. Do not be unduly concerned about the smutting, as it is more important that you concentrate on getting sufficient material plated onto the surface. Once this is achieved, the smut problem can be addressed.

To remove brush plating smut, simply polish lightly with a cloth. If this doesn't remove it all, try buffing lightly with a Canton Flannel Wheel and BLUE compound.

To improve the finish of a brush plated repair to a silver plate, we recommend a final clean/polish of the entire surface of the part with SILVERSMITH or SILVERPLATER solution.

Also plates onto Aluminum, lead, pewter, stainless if the base metal has been primed with its respective priming system.

### **BRUSH PLATING WITH NICKEL & COPY CHROME**

To ensure a good corrosion resistant surface on steel, go over the entire part twice, using brush strokes in different directions. Brush plating does not plate as evenly as tank plating, so make sure the part is well covered. If in doubt – do it again!

## **GOLD EMBLEM PLATING USING PLUGNPLATE**

The system must be applied to a nickel or buffed copper plate surface.

### **To plate emblems requires a two step process:-**

#### **1. Stripping. Removing the existing chrome.**

- Attach a plating wand to the NEGATIVE/BLACK terminal of your power pack. You can clip the alligator clip inside the end of the wand, ensuring electrical contact with the metal. Press the positive terminal plug to the work piece.
- Pour a small quantity of ANODIZE & CHROME STRIPPER solution into a plastic cup. Use only this liquid, and the original solution will stay fresh.
- Saturate the bandage with the stripping solution.
- Stroke the wand slowly & gently over the work piece. The bandage will turn yellow as the chrome comes off.
- The work piece will change color slightly as the chrome is removed.
- To ensure all the chrome is off, apply fresh bandage or rinse out the old, then dip in fresh solution and lightly repeat the process. If no yellow appears on the wand, then the part is successfully stripped.
- Rinse the part in fresh water.

- To remove chrome faster, you may attach the wand to a 12 volt power supply, rather than use the PlugNPlate adapter.

## 2. **Plating. Applying the gold plate.**

- Attach a Stainless plating wand to the red plug on the PlugNPlate adapter.
- Pour a small quantity of Gold solution into a plastic cup. Use only this liquid, and the original solution will stay fresh.
- Saturate the wand with Gold solution. Stroke the wand slowly & gently over the work piece.
- Initially you may increase the wand speed slightly, then, as the gold color forms, slow the speed down to build up a thicker layer of gold.
- The gold will become visible after 30 -60 seconds for 1-2 square inches of treated area.
- Repeat the gold application to increase the gold's durability.
- Finally, wash with detergent, and rinse with water.
- You may polish the metal with a proprietary metal polish. We recommend Collinite Metal Wax, as this has a very mild abrasive in it, which cleans off brush plating smut marks and at the same time waxes and protects the plate. Use sparingly on silver and gold plate.

### **Additional tips for Brush Plating**

Always check that the bandages are in good condition. Worn areas may allow the wand to touch the work piece, causing a short circuit and burning the work piece.

The gold wand bandage will become soiled with a green substance after plating. The degree of this will depend on plating action and time.

Dark spots or streaks that occur during the gold plating may be from brushing too slowly.

Remove and wash all bandages after use. Dispose of cotton ball.

Plate only articles that are in good condition. Gold plate will NOT cover imperfections, such as scratches and pits.

**Technical Tip.** Place the solutions (in a glass container) in a microwave, and heat on high for approx 30 seconds before plating, to attain approx 140 deg f.. At the same time, place the part to be plated into hot water. When warm, proceed with plating. The additional heat will dramatically improve plating speed

Plating larger objects can be more difficult than small ones. Practice your technique on the smaller objects first.

Some objects may actually be covered with a type of chrome paint or lacquer. Test the piece first by checking that it is conductive, using a multi-meter.

Trying to match existing gold supplied by another company is difficult as shades vary.

An application of a lacquer, or polyurethane, over a plated item will increase its wear, reduce water spotting and enhance the gold's color.

### **DIP PLATING with PlugNPlate**

Sometimes it is much easier to simply dip the part into the solution to plate it, especially if it is small with lots of detail. The PlugNPlate power supply and plating wand can easily be used for this procedure.

Pour all of the plating liquid into a small wide necked container, such as a glass.  
Place the plating wand into the solution and clip it to the side of the glass with a clothes peg.  
Attach the work-piece to the negative alligator clip and suspend the part into the solution.

### **The degree of plating will depend on several factors:**

1. **The amount of anode** (plating wand) immersed in ratio to the size of the part. The larger the part, the more surface area of the wand should be immersed. (Too much wand will make the plating appear smutty or dark).
2. **The distance of the anode from the work-piece.** Being too close will cause similar problems to #1.

3. **The temperature of the solution.** Generally, the warmer they are, the better they plate, and the less current you need.
4. **The duration of plating time.** This will depend on which plating kit you are using. Gold should only be plated until the color is right. Copper should be plated until the thickness is adequate, especially if you are using it to build up an area. Nickel and Copy Chrome should be plated for at least 5 minutes. Silver, being a soft metal, should be treated somewhat like gold, but make sure you have enough plating on the part to enable it to withstand polishing etc.
5. **Silver will often plate a dark smutty color.** This will polish off, but you can reduce this by plating with a very small amount of the wand immersed, or by using the Copy Cad PlugNPlate power supply. A final treatment using a sparing amount of Collinite Metal wax will also clean the smut and leave a wax protective film, which will reduce tarnishing. Swishing the part through the solution as it plates will also dramatically reduce the smutting problem.

Silver PlugNPlate kits are supplied with a 1.5 –1.7 volt power supply and a spare banana plug. Replace the red alligator clip with the banana plug for brush plating.

With silver and gold Plug N Plate systems, you may substitute the wand for a small piece of silver or gold. This will enhance the life of the solution. (Do NOT use plated items as the anode, they MUST be made of solid silver or gold. (The anode must be held so that the wire connection is out of the liquid, otherwise the wire will dissolve and contaminate the solution)

*Note the clothes peg holding the plating wand to the side of the glass.*

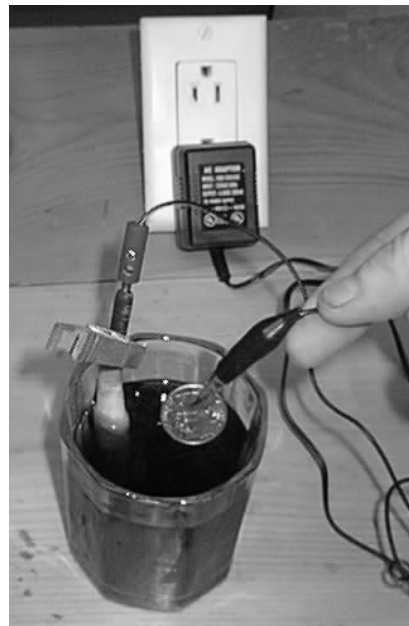

# FASTGOLD

For Professional Quality Brush & Pen Platers

Designed to eliminate the dangerous cyanide process from brush plating, **FastGOLD** is the obvious choice of professional gold brush & pen platers. The product will work with all types of brush & pen plating machines, giving superior results to most cyanide products.

**FastGOLD** is a new type of alkaline cyanide free gold plating solution that will plate over nickel, sterling gold, gold, rhodium, copper, brass and bronze. It is preferred that copper alloys are given a strike coat of nickel. It will not plate onto pot metal, any zinc alloy, zinc plate or steel, unless previously primed with nickel. The system will provide uniform color consistency and even coverage. In the case of chrome-plated items, the chrome must be removed to expose the nickel plate, before plating with gold.

## Surface preparation

All surfaces must be highly polished and thoroughly cleaned, with no corrosion. Buffing and polishing can best achieve this.

Use **FastGOLD** directly as supplied, alternatively make a gel by mixing in the thickening agent Cabosil. If using the latter, it is advisable to dampen the wand bandages with fresh water to initially aid absorption and conductivity.

SOLUTION TEMP RANGE (Deg F)	room
PLATING TIME	30-60 seconds
ANODE	Gold, graphite or stainless
ANODE BANDAGE	yes
VOLTS SHOWING ON VOLTMETER	4-10
AMPS REQUIRED PER SQ. INCH	Depends on m/c
FUME HOOD	no
USE AS A STRIKE COAT	no

## Brush Plating Procedure

Always decant a small amount of solution/gel into a separate container for actual usage. This will avoid inadvertently contaminating the solution with anything the bandage may pick up from the plating operation.

Dip the wand in the smaller amount of solution and NOT in the main bottle. You may repeatedly dip your wand into the smaller amount of solution.

Proceed to brush plate the area to be treated, using soft strokes, (somewhat like stroking a cat). Do not stop in any one place, otherwise 'burning' may occur. You should plate at about 5-10 sq. inches per minute. After a short while, you will find that the plating is no longer proceeding as quickly. This is because all of the metal has been used up from the solution contained on the wand., so re-apply more product to the wand.

If the plating has dark spots, speed up the wand action and press down harder. A few more passes over the darkened area will clean it up.

To plate car emblems, see the section **Gold Emblem Plating using PlugNPlate**

*FastGOLD* may be used with PlugNPlate kits

## ELECTROLESS NICKEL AND ELECTROLESS KROME PLATING

*Acid Nickel Process: 5-7% phosphorus*

These instructions now cover the Nickel and the Krome kits. Electroless Krome is a nickel/cobalt alloy, harder and bluer than nickel. Where these instructions refer to Electroless Nickel, this also means Electroless Krome. The only difference in the kits is the part A component, which, in the case of Krome, has the cobalt additive. You may use parts B & C for either type of plating, as they are completely interchangeable.

Electroless nickel/krome plating requires no anodes, power supply or electrical connection of any kind. The process simply involves mixing together some solutions, heating them to just off the boil, and then immersing the part to be plated. An auto-catalytic electrochemical reaction takes place and the nickel is evenly deposited all over the part being plated. The thickness of the plate will depend on the duration of immersion. To stop the reaction, the part is removed from the solution, which is allowed to cool before storing for later reuse.

Commercial electroless nickel platers usually employ full time chemists to make additions to the solution. This is a time consuming activity for a small operation and is not cost effective. Our system is designed around the KISS -'Keep It Safely Simple' principal, so you will not have to 'titrate' and mess around with this technicality. We have developed a straightforward way of estimating the nickel depletion of the bath, and fresh additions can easily be made to prolong the life of the solution. The procedure is much like balancing your chequebook.

The brightness of the plate will, to some extent, depend on the degree of polish existing on the part. The higher the shine initially, the brighter the plate. Surfaces requiring shiny finishes should be done in fresh batches of solution, otherwise they may have to be buffed to obtain a high gloss. The duller finishes resemble cadmium or Butler nickel, so are of great value to most vehicle restorers. Numerous variations can be achieved by changing the surface finish prior to plating.

Electroless nickel plating is not new; it has many applications in industry. Because the system plates evenly over all areas of the part, even down tubes and holes, it is frequently used for firearms and small hand tools. It is ideally suited for coating extrusion dies to assist in mold release and protection of the surface. For the motorcycle restoration enthusiast, electroless nickel has a great application for evenly plating the air-cooling fins on many engine blocks, particularly older Indians and Harleys.

Fortunately, electroless nickel is a fairly safe material, nevertheless, there are heavy metals (nickel) in the solution and this should not be disposed of carelessly. Our kits have a special system included to 'plate out' the excess nickel, rendering the rest of the solution harmless, enabling you to dispose of down a drain, or as per your local regulations.

The system consists of 3 main ingredients, parts A, B & C.

Mix parts A & B with distilled water to make up the initial solution. As this is depleted of nickel, further additions of part A and part C are made to keep the solution stable and plating brightly.



What is a 'Nickel Credit'?

It is the surface area in square inches, multiplied by the plating time in minutes.

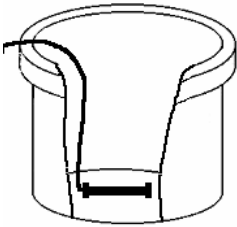

Ie: To plate a part that has a total surface area of 10 square inches, with a light decorative plate, we need to plate for 15 minutes to obtain 0.0025" thickness

Therefore,  $10 \times 15 = 150$  credits

0.5 oz of Part A added to 1 oz part C will make enough Replenisher to supply 240 credits

PROCEDURE	SETUP	OPERATING PARAMETERS	EQUIPMENT	SAFETY
1. SURFACE PREPARATION	Buff & Polish for a mirror finish. Bead Blast for a 'flat' finish. Nylon Abrasive wheel buff for a 'scratched brush' look.			
2. DEGREASING		140- 200 deg F No agitation 5 mins immersion  12 oz SP Degreaser 3 gal Distilled water	1 x 5 gal tank 1 x tank lid 1 x lid ring 1 x 200f heater 1 x 2lb SP Degreaser	Wear rubber gloves and goggles. Do not ingest 

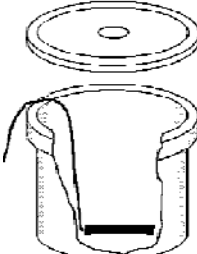
1. RINSE IN DISTILLED WATER SPRAY
2. WATER BREAK TEST
3. CALCULATE TOTAL SURFACE AREA AND PLATING TIME
4. CALCULATE CREDITS
5. CHECK for MAXIMUM LOAD 1.25 pint plating solution = 15 sq inches of plating surface area MAXIMUM!
6. CHECK for COPPER ALLOY – MUST BE ACTIVATED BY TOUCHING WITH STEEL for 2-5 mins when plating
7. PREMIX REPLENISHER if NEEDED

3. Tank Makeup		195 deg F No agitation Immersion time depends on plating thickness  Per 1.25 pints of plating solution required: 1 oz A, 3 oz B, 16oz Distilled water (makes 20 fl oz = 1.25 pints) MARK TANK WITH LIQUID LEVEL NOW	1 x 300W heater 1 x plastic tank 1 x tank lid (1 x tank ring) Mist balls	Wear rubber gloves and goggles. Do not ingest 
----------------	--	---	--	--

4. Plating Times	<b>Time</b>	<b>Application</b>	<b>Plate Thickness</b>
	15 mins	Indoor items, decorative etc.	0.00025 “
	30 mins	Hand tools, guns, nuts & bolts, brackets	0.0005 “
	60 mins	Marine, motorcycle, car or outdoor fitting	0.001 “

Tank Size In pints	MAXIMUM LOAD in sq”	NICKEL CREDITS	REPLENISH after 20% credit loss	REPLENISHER	
				Part A	Part C
1.25	15	450	90	0.1 oz	0.2 oz
5	75	1800	360	0.5 oz	1 oz
10	150	3600	720	1oz	2 oz
20	300	7200	1440	2 oz	4 oz
40	600	14400	2880	4 oz	8 oz

5. DETERMINE WHEN TO REPLENISH (after 20% credit loss) and HOW FREQUENTLY \*
- After replenishing:

6. TOP UP TANK TO ORIGINAL LEVEL WITH DISTILLED WATER.

- \*
- Example 10 pint tank = 3600 credits = 720 @ 20% loss. Part is 150 sq” @ 30 mins = 4500 credits. Therefore tank needs to be replenished 4500/720 = 6 times in 30 minutes. (approx every 5 minutes)
  - Example 10 pint tank = 3600 credits = 720 @ 20% loss. Part is 150 sq” @ 60 minutes = 9000 credits. Therefore tank needs to be replenished 9000/720 =12 times in 30 minutes. (approx every 2.5 – 3 minutes)
  - Example 40 pint tank =14400 credits = 2880 @ 20% loss. Part is 150 sq” @ 30 mins = 4500 credits. Therefore tank needs to be replenished 4500/2880 = 1 times in 30 minutes (Balance of 1620 carried forward to next run)
  - Example 40 pint tank = 14400 credits = 2880 @ 20% loss. Part is 150 sq” @ 60 minutes = 9000 credits. Therefore tank needs to be replenished 9000/2880 = 3 times in 30 minutes. (approx every 10 minutes) Balance of 360 credits carried forward to next run.

### Electroless Nickel Plating Troubleshooting

Problem	Cause	Remedy
No deposit	No current (or gassing from part) Incorrect solution ratio Copper alloy not activated	Incorrect bath temperature, increase temp Dump solution and make up fresh batch  Touch copper alloys with steel rod for 5-60 seconds until part starts to gas
Plate peels off or blisters	1. Poor preparation 2. Inadequate cleaning 3. Organic or metallic contamination 4. Improper zincating of aluminum	Check part with 'water break' test. Acid etch part. Check SP Degreaser is OK. Rework the part through the cleaning process Dump solution and make a fresh bath. Etch zincate off in mild acid, and re-zincate in fresh solution.
Pitted Plate	Impurities in solution Copious evolution of hydrogen gas	Dump solution and make up a fresh bath Surface are being plated should be reduced. If tank walls are gassing, they may be being plated. Clean tank
Rough Plate	Contamination of loose particles i.e.: dust nickel. Contaminated water used Particles of metal or soil on work	Filter solution through a doubled coffee filter. Discard solution and make up new batch using DISTILLED water Improve cleaning and rinsing process.
Dark deposits (esp. on low spots)	Zinc, lead or copper in solution	Plate out onto a dummy corrugated cathode. Zinc contaminants may show as alternating dark & lights areas. Air agitation must be on Adjust pH to 3.5 - 4.5
Streaks in Deposit	Gas streaks from position of work Poor agitation. Poor rinsing & or cleaning Metal & organic contamination Low surface area	Reposition work occasionally Agitate occasionally Improve cleaning and rinsing process Dump solution and make up fresh batch Increase the number of parts being plated
Poor corrosion/chemical resistance	Metallic contamination	Dump solution and make up fresh batch
Dark to black deposits	Metallic/organic contamination (usually caused by old zinc plate) Bath imbalance	Dump solution and make up fresh batch Soak part in weak solution of muriatic acid to remove old zinc plate
Poor wear resistance	Low heat treatment temperature &/or short time	temperature and time cycle should be adjusted
Laminar deposits	Poor temperature	Keep temp within range
Frosted deposits	Low work load Metallic/organic contamination	Increase work load Dump solution and make up fresh batch
Poor Adhesion on Aluminum	Metallic/organic contamination Improper surface preparation Improper zincate or other pre-treatment Improper heat treatment Re-oxidation	Dump solution and make up fresh batch Improve cleaning and rinsing process Replace zincate bath heating time and temperature should be corrected Reduce transfer time from zincate to nickel
Dull or matte deposit	bath more than 25% used Metallic/organic contamination Poor quality substrate Low temperature	Make up fresh batch -or- buff the part to a shine solution and make up fresh batch Improve polishing etc Correct the temperature
Poor coverage, edge pullback & frosted edges	Improper cleaning &/or rinsing Metallic/organic contamination	Improve cleaning and rinsing process Dump solution and make up fresh batch
Plating solution turns white	Solution is depleted	Solution may be contaminated with alkaline drag in. Dump solution
Plating solution turns grey	Solution is decomposing	See above. Prevent drag in. Dump solution
Part A has hard deposit in bottom	Caused by solution temperature dropping below 50 deg F	The deposit contains the nickel, and MUST be re-dissolved into the solution Simply heat up the liquid to 150 F and stir until dissolved.



### **MAXIMUM LOAD**

You may ONLY plate a maximum of **15 sq inches of surface area per 1.25 pints** of plating solution. If this amount is exceeded the bath will start to overwork and plating quality will seriously deteriorate. Therefore if the part is 90 square inches, you need a MINIMUM of  $(90/15) = 6 \times 1.25$  pints of solution. Of course, if your bath contains MORE solution, this is OK.

### **NICKEL CREDITS**

To provide us with a simple way of logging the usage of the bath, we are going to award each unit of new solution with 'Nickel Credits'. These are the sum of the square inches multiplied by the plating time in minutes.

**Each 1.25 pint of initial made up solution will plate:**

**7.5 square inches @ 1/1000 in 60 minutes.**

**15 square inches @ .0005" in 30 minutes.**

**30 square inches @ .00025' in 15 minutes.**

A 1.25 pint bath has total Nickel Credits of  $7.5 \times 60 = 450$ . Enter the 450 in the Nickel Credits column of the NICKEL CREDIT FORM and, just like balancing a checkbook account, enter the final balance in the balance column. (this is an account you cannot overdraw!)

### **NICKEL REPLENISHMENT**

In practice, the additions of 'replenishment' should be made during the actual plating process at approximately every 10 minutes. The total amount of replenishment should be calculated and made up beforehand. Ideally, the bath should be maintained at 80% efficiency. Letting the nickel deplete below 70% level will accelerate rapid deterioration of the bath. Failure to replenish the solution will result in the plate becoming dull and the bath eventually becoming out of balance and unusable.

The Nickel Bath Replenishment is a straightforward matter of adding more nickel from the Concentrate Part A, with an addition of Concentrate Part C.

If you have used the bath several times, you should keep a note of the time, surface area etc. using the log sheet. See blank form later in this section

### **REPLENISHING THE NICKEL PLATING BATH with Part A & Part C**

As soon as your chart shows you have depleted the bath by approx 20%, add REPLENISHER MIXTURE of part A & C

#### **ONLY ADD ENOUGH REPLENISHER TO BRING YOUR CREDITS UP TO 100%**

You may add the replenishment solutions at any time. After a wait of approx. 20 seconds, to allow the solution to warm up to its operating temperature, top up the solution to the original waterline with DISTILLED WATER.

You may make as many as 10 ( x 20%) COMPLETE additions of replenishment to the bath. Your additions will be noted on your 'Nickel Credits' form. After this, you should dispose of the solution and make a fresh bath with parts A & B.

#### **A note on bath replenishment.**

During the process of plating, a quantity of water will evaporate from the tank. Additions of DISTILLED WATER must be added periodically to maintain the correct dilution of the solution.

Make a note of the waterline when you first make up your solution. To make an addition, first, IF REQUIRED, add a quantity of REPLENISHMENT SOLUTION, then top up with distilled water.

*It is always advisable to add small amounts of both distilled water and replenisher frequently, say every 5 minutes, as this will keep the bath from cooling and becoming unstable.*

## NICKEL CREDIT FORM

Surface Area in Square inches	Time In minutes	Nickel Credits	Balance Of Nickel Credits
1.25 pint = 7.5 sq “ @	60 =	450	

### Operating the Kit

A new type of ceramic heater is now available that will bring the solutions to a boil in a plastic tank. The tank is now a plastic tank. These heaters may take from 15-60 minutes to bring the solution to 200 deg f. To accelerate the process, you may remove the metal handle and microwave the solution in the plastic tank or a glass vessel.

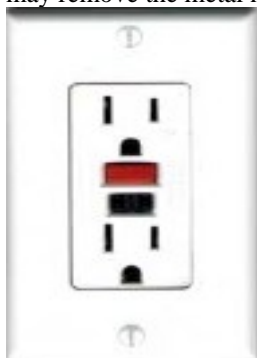

**DO NOT FORGET TO UNPLUG THE CERAMIC HEATING UNIT WHEN PLATING IS COMPLETED. IF LEFT UNATTENDED THE HEATER WILL EVAPORATE ALL SOLUTION, THEN MELT THE BUCKET AND MAY CAUSE A FIRE.**



**WARNING! THIS HEATER MUST BE PLUGGED INTO A GFCI RECEPTICAL**

*Important. Any part made which contains copper; i.e. copper, brass, bronze, must be 'activated' by physically touching the part with a piece of steel for several seconds (5-30). Alternatively, the part may be suspended on a STEEL wire, which will activate the nickel/krome plating process. You should see the steel rod/wire bubbling gently. When the copper part begins to bubble, it has accepted the reaction and will continue to plate successfully.*

### Chemical Disposal Procedure

Add enough household ammonia to make the plating solution turn blue Heat to 170 deg f. Using 1 steel pad per litre of solution, immerse them into the solution.

Add the END concentrate at the rate of 20 ml per litre of solution.

Heat the bath to 190-205 deg F approx. 1-2 hours until the solution turns water white.

The solution is now drain safe and can be disposed of.

Tank Size In pints	Quantity of Steel Pads	END In Fl oz
1-2	1	0.5
8-12	4	4
24	12	8

## **BORON NITRIDE ELECTROLESS NICKEL**

BN EN is an extremely slick, abrasion resistant, low-friction, high lubricity coating. It is ideal for all types of guns, engine pistons, fry pans, in fact anywhere where dry lubrication and non-stick is an issue. We see interesting potential in lining parts of Paintball Guns to prevent wear of the soft aluminum.

The coating can be applied in 20 minutes, to aluminum, steel, nickel, copper, brass and bronze. Other metals can be treated as long as a nickel plate is previously applied.

Where corrosion may present a problem, (such as on steel) the part should be previously plated with at least 0.0002" of Electroless Nickel plate. Generally gun components can be plated directly without a base primer of nickel.

The coating is applied at 0.0002" in 20 minutes. The system runs exactly the same as Caswell Electroless Nickel, except that it has a special filter pump, which agitates the Boron Nitride powder, keeping it in suspension. . The pump has a plastic tube, which should be secured to the pump body aiming the jet towards the bottom center of the tank.

As the nickel is plated onto the surface, the minute particles of Boron Nitride are bonded all over the surface of the nickel, giving the part unique properties.

The ceramic heaters supplied, have no thermostat, so they need to be manually turned off when the solution reaches 185 deg F. In an ambient room temp (approx 70 deg F) a 1.5 gal setup will take approx 20 minutes to cool to the minimum operating temperature of 165 deg F., so no further heating should be required. Careful attention to temperature during the last 10 minutes may show the need for a short burst of heat from the heaters. Operating at above 185 deg F will cause the bath to plate out too rapidly and it will start to deteriorate.

After plating, the pump should be left to run until the solution temperature has reached ambient again. At this point the plating reaction ceases. Failure to do this will result in the BN particles dropping to the bottom of the tank, where they will be plated into a solid mass. This will ruin both the particles and the solution.

The bath must be maintained at between 70-105% nickel content by replenishing with Part A & Part C. This procedure is defined later.

The BN Particles are slowly depleted from the solution. However, there will always be about 50% of these left over after 5 nickel replenishments. To recover the BN particles, the solution may left idle for 3-5 days and they will settle on the bottom. The spent solution may be carefully siphoned or decanted off and the BN particles may be re-used if they are free from nickel. For high output users, this may be an economical saving, as BN particles are a major expense of the kit. There is a special retrieval procedure involving nitric acid, which will remove the nickel. This information is available on request.

The BN EN finish has a satin look to it.



## MAXIMUM LOAD

You may ONLY plate a maximum of **15 sq inches of surface area per 1.25 pints** of plating solution. If this amount is exceeded the bath will start to overwork and plating quality will seriously deteriorate. Therefore if the part is 90 square inches, you need a MINIMUM of  $(90/15) = 6 \times 1.25$  pints of solution. Of course, if your bath contains MORE solution, this is OK.

## NICKEL REPLENISHMENT

In practice, the additions of 'replenishment' should be made during the actual plating process at approximately every 10 minutes. The total amount of replenishment should be calculated and made up beforehand. Ideally, the bath should be maintained at 80% efficiency. Letting the nickel deplete below 70% level will accelerate deterioration of the bath. Failure to replenish the solution will result in the bath eventually becoming out of balance and unusable.

The Nickel Bath Replenishment is a straightforward matter of adding more nickel from the Concentrate Part A, with an addition of Concentrate Part C.

### A note on bath replenishment.

During the process of plating, a quantity of water will evaporate from the tank. Additions of DISTILLED WATER must be added periodically to maintain the correct dilution of the solution.

Make a note of the waterline when you first make up your solution. To make an addition, first, IF REQUIRED, add a quantity of REPLENISHMENT SOLUTION, and then top up with distilled water.

It is always advisable to add small amounts of both distilled water and replenisher frequently, say every 5 minutes, as this will keep the bath from cooling and becoming unstable.

Keep a note of the temperature when adding Replenishment. The solution should ideally be at 180 deg F when adding to ensure the temperature drop does not go below 165 deg F.

## Operating the Kit

**A new type of ceramic heater is now available that will bring the solutions to a boil in a plastic tank.** These heaters may take from 15-60 minutes to bring the solution to 200 deg f. To accelerate the process, you may remove the metal handle and microwave the solution in the plastic tank or a glass vessel.



**DO NOT FORGET TO UNPLUG THE CERAMIC HEATING UNIT WHEN PLATING IS COMPLETED. IF LEFT UNATTENDED THE HEATER WILL EVAPORATE ALL SOLUTION, THEN MELT THE BUCKET AND MAY CAUSE A FIRE.**

Areas not requiring to be plated may be masked with 2 coats of Mask-it. This should be allowed to thoroughly dry between coats, otherwise the hot solution may cause the coating to peel.

Important. Any part that contains copper, brass or bronze must be pre-plated with nickel.

## BLACK OXIDIZING OF STEEL

This 'room temperature' Black Oxidizing system is a new technology in the blackening process, often known as 'Parkerizing'. Developed by a company specializing in hot blackening processes to eliminate the hazards and fumes from their process, this method is rapidly gaining favor with all types of metal finishers. Although Black Oxide does not provide the degree of protection given by plating, it does serve an important role in metal finishing. Ideally suited for nuts and bolts, where any increase in dimension would ruin the part, this process is used in many vehicle restoration applications. The system is also ideal for hand tools, subject to knocking, where a plated surface would simply chip off.

### ***TO MAKE THE BLACK OXIDE SOLUTION***

Pour 9 pints DISTILLED WATER into a plastic container.  
Add 1 pint Black Oxide Concentrate (blue liquid).  
(For larger quantities, keep the water and concentrate in the same ratio)

TANK TYPE	Dipping
SOLUTION TEMP RANGE (Deg F)	60-140
DIPPING TIME (Mins)	3-10
PH	1-3

Leave for 30 minutes to age.

Soak the part in SP DEGREASER for at least 5 minutes. Rinse in fresh water, or if not available, a good hot detergent solution.

Remove all rust using PICKLE # 1 or sand blast. Rinse in fresh water.

Immerse the part in the BLACK OXIDE CONCENTRATE for between 2-10 minutes. If the part is not suitably blackened, lightly brush with a soapy steel wool pad, rinse and re-immerses. As an alternative, you may wish to Electro-strip the surface for 20 seconds. See the section on Electro-stripping. A brown smut over the part is indicative of being immersed for too long. Clean off the smut with steel wool etc. and re-immerses for a shorter period.

Dip or brush the part in PENETRATING SEALANT ensuring it is thoroughly saturated. Soak for approx. 5 minutes. Shake off excess material and allow to dry. Both solutions may be used repeatedly.

To speed up the blackening process, warm the BLACK OXIDE CONCENTRATE to approx. 140 deg. f. The degree of blackening will vary depending on the type of steel and the time immersed.

The BLACK OXIDE CONCENTRATE forms a whitish sludge, which sinks to the bottom of the tank. This is harmless to the process, but may be removed by periodically straining through coffee filters.

The rich black color will not occur until you seal the surface with PENETRATING SEALANT.

Oil the part in the normal manner using the PENETRATING SEALANT. Alternatively, you may lacquer the part with a flat clear lacquer.

For a more durable finish, plate with Copy Cad or Zinc, then use the Zinc Blackener process. This does add dimensional thickness to the part.

## RUB ON SILVER PLATING



### SILVERSMITH & SILVERPLATER

Articles that are normally silver plated include: flatware, tableware, ornaments, jewelry and headlight reflectors on older vehicles.

Using no electrical power at all, both SilverPlater and SilverSmith are applied with a small piece of cloth (chamois leather is ideal) and by gently rubbing the part to be plated, the pure silver is deposited from the liquid onto the part. The friction sets up static which deposits the silver. This material is ideal for any item, which has worn and tarnished silver plate, which is usually patchy in the high wear areas. The action of rubbing activates a mild cleaner which removes existing tarnish and dirt, and then lays down a layer of silver onto the cleaned metal.

Silver plate naturally tarnishes and is easily worn away the by repeated cleaning. Using SilverPlater or Silversmith as a cleaner actually adds more silver to the part each time you clean, so it will never wear through again. If you have trouble in getting a plate to appear, simply warm the bottle of SilverPlater and the part, by immersing them in a pail of hot water. Dry the part, and then continue to apply the solution. The heat will dramatically increase the plating activity.

You cannot apply SilverPlater & Silversmith to Pot Metal or Steel. Ideally they should be applied over a nickel plate, but can be applied over copper, brass, bronze, nickel, zinc and existing silver. If the original plate is worn below any of the base plates, exposing steel or pot metal, you should brush plate those areas with a nickel plate before re-silvering.

It is very important that you wash the part in hot water, immediately after the application of SilverSmith or SilverPlater, otherwise the residual chemicals will tarnish the silver.

SilverPlater is a milder version of the product containing NO cyanide; anyone can purchase it. The application will take a little longer than using Silversmith, rubbing from some 30 seconds to 1 minute before the plating becomes apparent. Silversmith contains cyanide, and is forbidden in domestic households by Federal Law. We can only ship this to registered businesses. It works in exactly the same way as SilverPlater, but much faster, 10-20 seconds. We recommend this product to commercial setups, especially for flatware and headlight reflectors.

The use of SilverSmith or SilverPlater as an overall cleaner after using the PlugNPlate silver brush plater, will help blend in areas that have been repaired using the brush on PlugNPlate system. The latter will lay down heavier layer of silver much faster than the rub-on technique.

At typical repair technique would be to:

- Clean the area using 'Soft Scrub' the kitchen cleaner
- Polish the worn area, using a buffer with jewelers rouge or blue compound & a soft wheel.
- Apply a heavy layer of silver plate using the PlugNPlate brushing technique to the damaged area.
- Apply SilverSmith or Silverplater to the entire workpiece, blending in the repair.
- Apply a coat of Collinite Fleetwax, or any carnauba wax product.
- Polish with a very soft cloth.

*Silverplater contains Silver Nitrate which is poisonous.*

SilverSmith contains a small amount of cyanide -which is extremely poisonous. Read the product labels for full instructions.

## ANTIQUING OXIDIZERS

All the products listed below are supplied in 16 oz bottles, except A02, which is in an 8 oz bottle.

The key to success with all these oxidizers is to experiment with temperature and time of immersion. Ideally the solutions should be at 65-75 deg F.

After producing the desired color, a variety of methods can be used to expose the underlying colors. Buffing the oxide off using wire wheels, cotton wheels with compound, or simply scratch cleaning with steel wool will give pleasing effects. Experiment!

Matt, clear lacquers and Collinite metal wax will seal the surface.



Code	Description	Application
A01	<b>Tiffany Green</b>  The original solution for the 'greening' of the copper components of Tiffany lamps.	Apply the solution, undiluted, with a soft paintbrush. Allow the reaction to work on the copper overnight.  You may also apply a matt clear lacquer to seal the surface.
A02	<b>Bronze &amp; Blackening Solution</b>  For use on Copper, brass and Silver.  Varying the solution strength and the time of immersion can produce an almost infinite range of shades.	Mix 1-2 fluid oz of Concentrate to 1 gal water depending on degree of effect required. Use at room temperature.  Dip item into solution for 5-10 seconds, longer for darker effect. Rinse to stop coloring effect.  For the 'French Grey' effect on silver, scratch-brush or buff the high spots to expose the underlying silver.  Add 1 fl oz household ammonia per gal of solution to preserve the mixed solution
A312	<i>Chocolate Brown</i> Produces a chocolate brown to antique brown finish on copper and brass.	Mix 15% concentrate with 85% water. Use as a dip at room temperature.
A313	<b>Black &amp; Brown Oxidizer</b> Blackens silver and nickel and browns copper and brass	Mix 15% concentrate with 85% water. Use as a dip at room temperature.
A316	<b>Verdi Green</b> On brass and copper	Mix 15% concentrate with 85% water. Use as a dip at room temperature.
A325	<b>Pewter Blackener</b> For pewter only	Mix 15% concentrate with 85% water. Use as a dip at room temperature.
A360	<b>Zinc Blackener</b>	A room temperature blackening process for die cast and plated zinc surfaces. The very mild acidic liquid concentrate is diluted with 9 parts of water for a 10% by volume working solution. Immersion times of 2 - 5 minutes. Equally effective on cadmium surfaces.
A385	<b>Aluminum Blackener</b>	An immersion or swab-on finish at room temperature for aluminum surfaces. Mild acidic liquid concentrate used full strength for swab-on finishing and touchup finishing or diluted with 4 parts water for immersion finishing. Frequently used to produce an imitation pewter finish on aluminum surfaces.
A324	<b>Swab On Copper Blackener</b>	An instant acting swab-on/touch-up chemical conversion finish for copper and its alloys. Color can be varied from light brown to brown-to-black
A370	<b>Stainless Steel Blackener</b>	An acidic liquid concentrate used full strength or diluted with up to 3 parts water to blacken stainless steel at room temperature. Recommended for color coding parts and blackening engravings on stainless steels. Produces a pleasing dark gray/black finish.



## PLATING PLASTICS AND NON CONDUCTORS



Plastic, being a non-conductor, has to be made conductive for a plate to adhere to its surface.

Silvaspray is designed to bond tenaciously to most plastics. It will also cover most other nonconductive materials, giving good adhesion.

Connect wires to the part to be plated, in order to conduct electricity to the part for plating. It is important that you do this **PRIOR** to coating, to enable the coating to make contact with the wire.

Apply by spray or brush, an even coat of SILVASPRAY Silver Conductive Paint

Attach a copper wire to the item, to conduct the electric current. Shake the canister vigorously for at least two minutes. Pour the liquid into the spray gun (air brush etc) and check for sediment in the original container and if present, remix the solution until all copper sediment is suspended in the solution. You may add up to 5% ethyl alcohol to aid spraying with an air-brush.

Spray a light mist coat onto the part, and allow to dry for at least 5 minutes (@ 68 f min). Spray a second heavier coat, at about 12" from the object, ensuring you spray up to and over the copper plating wire. Allow to dry for at least 15 minutes.

Plate the part for approx 30 minutes in Bright Acid Copper. Once plated with copper you may polish lightly, then nickel and/or gold plate.

**SILVER NITRATE TECHNIQUE.** The following technique is useful when fine detail of the original is required. Items such as leaves, insects, cloth, intricate moldings, as well as larger items may be treated this way.

The part must be capable of being 'wetted' evenly as this is an immersion process. Some items may need to be dried out first, such as plants. Place them in a jar with silica gel, or potassium carbonate for several days.

Make up a solution of:-

- 1/4 oz Silver Nitrate - available at photography supply stores.
- 5 oz rubbing alcohol - available at drug stores
- 5 fl oz distilled water

Brush, spray or dip the part in the solution, and allow it to dry. The silver nitrate now needs to be converted to silver sulfide to make it a conductive surface.

Place about 2 fluid oz of Caswell Bronzer solution into a glass vessel. .

Hang the part on a thread into the container.

In a well ventilated area, pour 1 fluid oz of battery acid solution into the Bronzer solution.

Immediately cover the container. Noxious fumes are emitted.

The fumes will then convert the coating to a conductive surface. After 5 minutes, remove the item and proceed to plating with copper.

## BRONZING BABY SHOES

BABY SHOES - Replace laces if worn. Wash the shoe and laces separately in detergent and allow to dry. Tie the laces, and allow them to fall naturally. Glue them into position using a hot melt glue gun. Glue the tongue into position. Cut off any frayed stitching etc.

To aid in sinking the shoe, you may pour some plaster-of-paris into the toe. This will also help the shoe keep its shape. Allow to thoroughly dry. Affix plating wires to the shoe. You could put a couple of wood screws in the sole and heel of the shoe and also use the shoelace holes. The more wires the better conductivity you'll get.

Immerse the shoe into the mixed CASWELL SEALER for 30 minutes, stirring occasionally to remove any entrapped air bubbles in the toe area. CASWELL SEALER comes in concentrated form. 1 quart of sealer must be mixed with 2 quarts of LACQUER THINNERS (not supplied) before use. Make a shoe rack by hammering several 4" nails into a small plank of wood. Invert the shoe over the nail and allow it to drain and thoroughly dry for about 4-8 hours.

Dip the part into CASWELL SEALER momentarily, and allow to dry, then repeat. Spray SILVASPRAY, Silver Conductive Paint over the entire shoe. The coating should extend into the shoe as far as possible. Allow to dry. Make sure the wires are well coated; otherwise you will not conduct power to the surface of the shoe.

Suspend the shoe from the tank bar, which should already be wired to the power unit, and immerse in the bright acid copper plating tank. The shoe should immediately start plating. The average baby shoes will measure approximately 25-30 square inches so should be plated at the rate of (1 amp per 20 sq ") 2-3 amps.

Plate for approximately 1 hour. Remove and inspect. Sand/emery any rough spots. Continue plating for about 3-5 hours, checking periodically for any rough spots, which should be sanded smooth. Smooth cloths and leather will have different appearances. Rinse the part off, then polish lightly and then proceed to the section in this book, ANTIQUE AND BLACKENING TECHNIQUES, for a choice of antiquing finishes, or plate with nickel and/or gold, or the bronze plating kit.

Antiquing solutions will give a bronze look, and with some buffing, the copper color underneath can be exposed, giving an antiqued look. For an all over finish of bronze, plate with the Bronze Plating Kit.

If plating with bronze, nickel, gold or silver, then the part needs to be polished to a high shine, to give best effect. Brush the shoe with steel wool or a soft buffing wheel and compound to remove the antiquing oxides and expose the copper on the high spots. Finally dip into CASWELL SEALER and rack to dry.

## PLATING LEAD, PEWTER AND STAINED GLASS OBJECTS

### Stained Glass Objects

Remove all excess flux, dirt, grease and glue by cleaning/washing pieces thoroughly. We recommend using a dishwasher and skipping the dry cycle.

Glass containing leaded/iridescent can cause the glass to be plated, and it can contaminate the plating tank.

Copper foil and other types of wires can also be plated. If using copper foil, be sure that you use enough solder or reinforcing wire to insure a strong product. Tinning over the copper foil ensures a stronger bonding of the glue.

Lacquered items, such as instruments, bows and other attachments, will plate poorly or won't plate at all. These small items, as long as they aren't plastic, may be stripped prior to plating.

Well-soldered joints will help stained glass pieces to hold their shape when plating.

Lead Came, pewter and 60/40 solder are normally difficult to plate, unless the metals are pretreated. The dull oxide layer that quickly forms after cleaning must be removed prior to plating. To achieve this, the lead work must be cleaned, (dishwasher etc) and then polished to a high shine using a metal polish. Ensure no waxes are left on the work piece.

To prepare lead or pewter items such as fishing lures, these need to be polished. The use of a vibratory tumbler is ideal to obtain a high shine on the lead work. Items should be freshly cast, and free from heavy oxides. No washing is necessary, as no soldering using fluxes etc. has been carried out.

To remove any oxides, make up a solution of **Pickle # 4**, at the rate of 4 to 8 oz/gallon and immerse for 30 seconds to 2 mins.

Rinse the parts off in distilled water and proceed immediately to plating them.

Plate the parts for a minimum of 15 minutes with Flash Copper.

To gold plate, we suggest you apply gold onto a nickel plate. The latter may have already been plated over a copper plate, so this becomes a 3 step process. A nickel plate using BRIGHT NICKEL will take directly to the prepared metals. Gold plating lends itself to the brush plating technique, as it plates quickly. The gold plating solution is also relatively expensive, so making up 'immersion plating tanks' can become cost prohibitive. Brush plate the gold on until the part achieves the correct color. Over plating simply wastes gold. You may wish to lacquer the gold finish to protect it from wear.

Finally, wax and polish the parts with Collinite Metal Wax.

## WASTE DISPOSAL & EMISSIONS

The plating industry is considered to be a generator of hazardous waste. The EPA has grouped hazardous waste producers into different categories, depending on THE AMOUNT OF WASTE THEY CREATE.

The government has strict regulations for the disposal of toxic chemicals, most of which are generated from the rinsing of parts between plating processes. If the government or local authority does not consider the material in question to be toxic, then you may legally dispose of it in the normal fashion, usually into a drain.

On first glance, it would appear that anyone doing any plating at all on a small scale would fall into the category of CONDITIONALLY EXEMPT SMALL GENERATOR. (CESQG). However, this is not actually the case, because, most of our customers are not producing ANY hazardous waste on a daily, weekly, monthly or annual basis.

How is this Zero Waste policy achieved? Firstly, a great number of our clients are only plating the occasional item, perhaps firing up their tank once every couple of months. Therefore, quite simply, if they are not using the kit, they are NOT a hazardous waste producer.

### **Recycling the rinse water.**

CASWELL Inc has been advocating a 'zero waste water' policy for some years, something that commercial plating shops are just beginning to consider. Rinsing plated parts in distilled water, then returning that water to your plating tank as 'top up' water, virtually eliminates all and any waste rinsing water problem. Very few plating shops do this, presumably because of the expense of using distilled water. However, considering the small scale of operation that our kits are used, the cost of one or two gallons of distilled water is hardly an issue.

This simple act of rinsing in the 'topping up liquid' means that you do NOT fall into the category of 'Hazardous Waste Producer'.

Most CASWELL plating systems have extremely long lives, and do not normally require replacing.

However, when the time eventually comes that you DO need to dispose of them, it is at this stage that you need to reconsider your status as a hazardous waste generator.

Many of our systems are not considered hazardous waste, such as SP Degreaser, Zinc and Copy Cad solutions, etc. When disposing of these, flush with plenty of water to thoroughly dilute and disperse the solution. Others such as BRIGHT NICKEL, Copper, Copy Chrome & Chrome contain heavy metals and need to be handled carefully. Some other chemicals can be treated to render them non-hazardous.

Electroless nickel, Pot Metal Primer and Electroless Krome have their own special treatment to remove the heavy metals from the solution (See below) Once the treatment is completed, the residue can be disposed of without consideration of a heavy metal being present.

Once you decide to dispose of hazardous materials, you then fall into the CONDITIONALLY EXEMPT SMALL GENERATOR.(CESQG) category, as designated by the EPA, (ENVIRONMENTAL PROTECTION AGENCY)

To ensure you are up to date with the latest requirements, we suggest that you contact the EPA by visiting their website at [www.epa.gov](http://www.epa.gov), or phoning their hotline at 1 800 424 9346 or 1 800 368 5888

### **Disposal of Copper Plating Solution.**

There are two hazardous elements in the copper plating solution., the acid, and the copper metal.

To remove the copper from the solution, set up the tank with 2 large steel sheets facing each other, one for an anode and the other to be used as a cathode. Using a battery charger, connect the positive terminal to one plate, and the negative to the other. Switch on the charger and leave it on for several hours. You should turn up the voltage to 12 volts, and put the amperage setting as high as possible without the cut-out switch coming into play.

After several hours you will notice that the negative plate is covered in copper and all around it there is a copper sludge or dust. Clean out the sludge/dust, then restart the procedure. Keep this up until no more copper dust is evident.

At this point, remove the plates and throw into the liquid quantities of steel machining swarf, metal filings, steel wool etc. If there is any copper remaining in the solution, it will plate out automatically onto the steel. This may take several hours. Watch the solution carefully, you will notice tiny bubbles rising from the metal. When the bubbles stop, remove the steel and repeat the process until no further 'pink' is present on the fresh steel. The solution will look almost clear.

Dispose of the copper dust and copper coated steel as scrap metal.

Finally, gradually add baking soda to the solution until no fizzing occurs. This will neutralize the acid in the solution, making it safe to dispose of. When flushing, add copious amounts of water to dilute the solution.

### **DISPOSAL OF CHROMIUM SOLUTION**

To destroy chromic acid in spent solution containing about 5 ounces per gallon chromic acid.

1st STEP: If necessary, adjust pH to 2.0-2.5 by adding Sulfuric Acid.

2nd STEP: Add about 1 pound of Sodium Bisulfite slowly with constant stirring. Theoretical requirements are 3 pounds of Sodium Bisulfite for each pound of Chromic acid. Reaction will take about 30 minutes. Color should be greenish.

Check for chromic acid by use of Kocour WCR Chromium Test Set. No blue or purple should show when all chromic acid has been reduced.

CAUTION: Provide adequate ventilation. Heat and fumes are given off. Cold water can be used to cool solution. The pH must be controlled to 2.0-2.5

3rd STEP: Add about 1/3 pound Caustic Soda slowly, with stirring, until pH 7.0-8.0 is reached. Theoretical requirements are 1 pound of Caustic Soda for each pound of Chromic acid in solution. Color will change to green and heavy precipitation will occur.

4th STEP: Let precipitation settle for about 30 minutes. If pH has gone above 8.0 reduce it by adding dilute (1 add to 4 water) Sulfuric Acid solution and check with Blue Litmus Paper which turns red at 7.0 as pH is reduced from higher value.

The liquid can then be diluted and safely drained. Sludge is disposed of separately if necessary.

NOTE Kocour Chromium Test Set CWR, Procedure 255, can be obtained from Chemical Distributors Inc., 80 Metcalfe St. Buffalo NY 14206

### **DISPOSAL OF ELECTROLESS NICKEL, KROME & POT METAL PLATING SOLUTION**

Add enough household ammonia to make the plating solution turn blue

Heat to 170 deg f

Using 1 steel pad per liter of solution, immerse them into the solution

Add the END concentrate at the rate of 20 ml per liter of solution.

Heat the bath to 190-205 deg F approx. 1-2 hours until the solution turns water white.

The solution is now drain safe and can be disposed of.

<b>Tank Size</b> In liters	<b>Quantity of Steel Pads</b>	<b>END</b> In millilitres
1	1	20
4	4	80
12	12	240

SAFETY PRECAUTIONS: Always provide ventilation, safety clothing and eye protection when treating wastes.

*Adding acids to alkalis, or vice versa, is dangerous. Drain waste treatment residue when water use is at a maximum so that effluents are diluted to the greatest possible extent*

## DISPOSAL OF ACID BATHS

Plating pickle tanks are normally made of either muriatic or sulfuric acid. Both of these tanks can be neutralised in several ways. Muriatic & sulfuric acids are good concrete cleaners. Muriatic acid is specifically sold for the purpose, so you can clean up an old floor with it prior to painting.

Wear an acid gas respirator and have plenty of ventilation, then pour the acid onto the floor and scrub with a brush. There will be a violent reaction for a few seconds as the acid works on the concrete. The alkalinity of the concrete will neutralise the acid which can then be safely hosed away.



Check with your local authorities if you are using large quantities as there may be some regulations regarding limits on spent acids into drains. Alternatively, slowly pour quantities soda ash, sodium bicarbonate, limestone, or lime, until acidity is neutralized, then dispose of the remaining liquid.

### Disposal of Sludge, waste concentrate.

Set aside a separate lidded plastic containers and place all sludge, residues etc. in them. Mark the container as TOXIC waste, with the name of the chemical. You may also add a box of Baking Soda to neutralize any acid. Dispose of this at your local 'transfer station' or any waste management company where they will take small quantities of household chemicals, in accordance with local regulations.

## CHROMIC ACID FUME EMISSIONS

Fume suppressants are wetting agents, also known as surfactants and are used to reduce mist produced during chrome plating. Due to the high current used, relatively violent bubbling occurs during plating, causing small particles of the chromic acid to become airborne. They function by reducing surface tension, and this eliminates the airborne bubbles.

The EPA recognizes the use of fume suppressants for decorative chromium platers and chrome anodizers. The surface tension must be below 45 dynes/cm. If chrome platers are successful in meeting this surface tension requirement, they are not required to perform emissions testing to demonstrate compliance with emission standards.

In a nutshell, this means that as long as you have applied the 'Fume Suppressant' supplied with the kit, you are automatically meeting this requirement, and do not need to test for it. We actually supply twice as much chemical as required. The installation of the Fume Control Balls also reduces the mist rising from chrome tanks, so you have approximately 3 times more protection than the requirements.

Depending on the size of your tanks and the frequency of use, you may need to periodically check the effectiveness of your mist suppressant. This is an EPA requirement, and is good for your health.

We suggest that you test your tank every time you use it by holding a sheet of white paper horizontally over the top of the tank during a plating operation. Keep the paper about 4" above the surface. Hold it there for about 30 seconds, then remove it and inspect the underside. If the paper is clean, no further action is required. If the paper is stained brown, then the Fume Suppressant system is failing. This is not an official test, but it does give you an early indication that something is wrong.

At this point, you may wish to carry out the monitoring required by the EPA, which is to test the surface tension of the solution using a device called a Stalagmometer. (These are available for rental from Caswell Inc) This is a special calibrated glass tube, which indicates the efficiency of the system. The requirement is that if the test fails, then you must add more Mist Suppressant. You could however, report in your log that the test failed, without actually carrying it out, and then simply add another dose of fume suppressant. This would bring you into compliance once more.

Monitoring frequency is detailed in 40 CFR Subpart N 343(c)(6).

Staggered time frequency is written in the regulation. Refer to 40 CFR §63.343(c)(5)(ii).

### Abstract:

*The hard chromium electroplating industry has been affected by numerous air quality regulations on both the state and federal levels. In 1995, the U.S. Environmental Protection Agency promulgated its National Emission Standards for Chromium Emissions From Hard and Decorative Chromium Electroplating and Chromium Anodizing Tanks. Under these standards, facilities that perform industrial or functional chrome plating must demonstrate that chromium emissions do not exceed acceptable limits, and must satisfy monitoring, record-keeping and reporting requirements. Various chemical and mechanical strategies for air pollution control exist to accomplish these goals. This report evaluates the use of control technologies and fume suppressants to extract, recover or suppress chromium emissions before venting the exhaust air to the atmosphere.*

For more information on chrome emissions, please visit the websites @

<http://www.cdphe.state.co.us/ap/chromium/html/index.html>

<http://arbis.arb.ca.gov/toxics/atcm/chroatcm.htm>

<http://www.nysefc.org/tas/sbap/fact%20sheets/work%20standards.htm>

Decorative chrome plating operations that use fume suppressants as the control technology are proposed to be permanently exempted from Title V permit requirements. Contact the State EPA for the other sources.

### **Report from the United States Environmental Protection Agency**

***EPA-453/F-95-001 March 1995 Office of Air Quality Planning & Standards (MD-10)***

#### ***New Regulation Controlling Air Emissions from Chromium Electroplating and Anodizing Tanks***

In November 1994, the U. S. Environmental Protection Agency (EPA) issued national regulations to control air emissions of chromium from chromium electro-plating and anodizing tanks. The regulation appeared in the January 25, 1995 edition of the Federal Register [volume 60, beginning on page 4948]. The regulation affects all facilities performing hard and decorative chromium electroplating and chromium anodizing, regardless of size. Over 5,000 facilities are affected nationwide.

#### **Why is EPA regulating electroplating and anodizing tanks?**

The Clean Air Act (CAA), as amended in 1990, directs EPA to regulate emissions of 189 toxic chemicals, including chromium compounds, from a wide range of industrial sources. EPA is regulating emissions of chromium from electroplating and anodizing tanks to meet the requirements of the CAA. The hexavalent form of chromium is highly toxic and strongly suspected of causing lung cancer. Less is known about the cancer risk of the trivalent form of chromium, but it can accumulate in the lungs and may decrease lung function after continuous exposure.

Hard chromium electroplating operations deposit a thick layer of chromium directly on a base metal to provide wear and corrosion resistance, low friction, and hardness (for hydraulic cylinders, industrial rolls, etc.). Decorative chromium electroplating operations deposit a thin layer of chromium on a base metal, plastic, or undercoating to provide a bright finish and wear and tarnish resistance (for bicycles, auto trim, tools, etc.). Chromium anodizing operations form a chromium oxide layer on aluminum to provide corrosion and wear resistance (for aircraft parts, architectural structures, etc.). Except for the trichrome decorative process, which uses the trivalent form of chromium, all other electroplating processes use the hexavalent form of chromium.

Chromium electroplating and anodizing tanks are one of the largest sources of chromium emissions. Over 5,000 facilities with chromium electroplating and/or anodizing tanks exist in the United States; many are located in small shops (using one plating tank) that are within close proximity to residential areas. EPA estimates that full compliance with its new regulation will result in a reduction of about 173 tons of chromium emitted into the air annually, or about a 99 percent reduction from today's levels.

#### **How does the new EPA regulation affect you?**

The regulation affects all facilities that use chromium electroplating or anodizing tanks, regardless of size. How you are affected depends on the size and type of shop (hard, decorative, or anodizing) you have and the technique that you use to reduce emissions. Decorative chromium electroplating operations must be in compliance with the regulation by January 25, 1996. Hard chromium electroplating and chromium anodizing operations must comply by January 25, 1997. In general, the regulation requires:

- Emission limits
- Ongoing monitoring
- Work practice standards
- Recordkeeping
- Initial testing
- Reporting

These requirements are summarized below. Also, EPA has published a guidebook entitled "A Guidebook on How to Comply with the Chromium Electroplating and Anodizing National Emission Standards for Hazardous Air Pollutants" (EPA-453/B-95-001) that provides a more detailed explanation of the regulation. The information in this fact sheet is intended for general reference only; it is not a full and complete statement of the technical or legal requirements associated with the regulations. Local and government regulations are continually changing. Please contact your local EPA office and local authority for further details. You will find both offices friendly and helpful.

## TECHNICAL SUPPORT

Our customers have, at some time or another, already experienced the problem you are concerned with. We have taken these subjects seriously and addressed them in manual updates etc. However, your BEST solution to all technical support problems is to go to our 'Finishing Forum' at <http://forum.caswellplating.com/> Here you will find in depth discussions, photographs, suggestions, and real answers.

You can post you question, along with photographs, and let your peers help you through the difficulty. We currently have some 42000 members regularly reading these posts. Many are EXPERTS in their field, whether it be powder coating, plating, polishing, or anodizing. This expertise shines out from our forum. Use it! It is your BEST tool.

You may also use the SUPPORT SYSTEM on our web page to troubleshoot and resolve technical support problems. Go to <http://support.caswellplating.com>

When using these facilities, please provide as much detail of what you did, i.e.: temperature of tank, amps, base metal, surface area, etc. etc



## The WATER BREAK TEST

Also recognised as ASTM-F-22

This test is probably one of the most important procedures in any plating or anodizing operation.

Make sure you carry out this test after doing all the preparation work, including degreasing and etching in pickles.

### To pass the test water will sheet off the part rather than bead off.

Take a cleaned and dried part and set it in a vertical position.

Use a spray bottle containing distilled water.

Spray the part two to three times from at least 6" away.

If the part is clean and free of oily residue, the water spray should sheet off.

If some oily residue remains, the water will tend to bead on the part

Repeat the cleaning process until the part passes the test.

Alternatively, apply several drops of distilled water to the cleaned surfaces.

If the surface is inadequately cleaned, the spherical form of the drop is largely retained, and the surface must be cleaned once more.

If the water runs on the treated surface, then wetting has been satisfactory and the part is ready for plating.

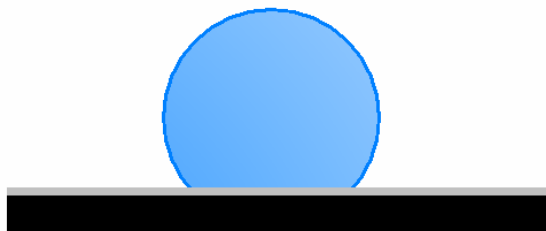

*Oil/dirt film makes water bead up*



*No oil/dirt film allows water to cover part*

### RINSING WITH DISTILLED WATER

The part should be raised out of the solution and sprayed liberally with distilled water.

The runoff should be allowed to drain into the tank.

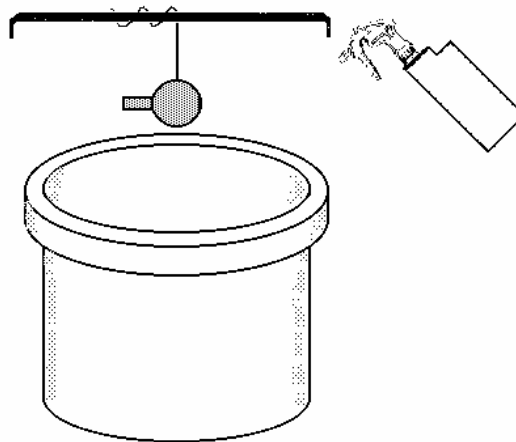

## Calculating Surface Areas for Electroplating Purposes

In order to apply the correct amount of current to the work piece, we need to have a good idea of the total surface area being plated.

**Caswell plating solutions have fairly precise current requirements, and using too much or too little power can seriously affect the end result.**

Excessive power will result in a rough, dark finish, with poor adhesion properties.

Insufficient current will result in only areas nearest to the anodes being plated.

Most parts being plated are awkward shapes, which, at first glance, could mean much time is spent calculating the surface area. This would, of course, be unproductive, so we need to define the degree of accuracy needed here.

As there are several other variables which affect the current, such as bath temperature, distance from the anode, and rectifier fine-tuning, we do not need 100% accuracy with our calculations. In fact, a 10-15% error factor is quite acceptable. This tolerant operating range greatly simplifies our calculations.

Lets begin with FLAT surfaces and the calculations needed for these. Once we have established the flat surfaces, we can go onto the more complicated calculations of three-dimensional objects.

Here are several basic shapes with their formulae and an example calculation.

We have substituted  $\pi$  or  $pi$  (pronounced 'pie') for 3.14. ( $pi$  is used in circle/ellipse calculations)

**h= height      l= length      r = radius      b = base w = width**

**Square**

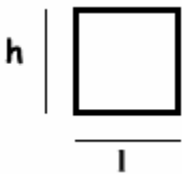

$$h \times l =$$

$$2'' \times 2'' = 4sq''$$

**Rectangle**

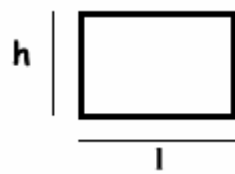

$$h \times l =$$

$$2'' \times 3'' = 6sq''$$

**Circle**

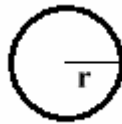

$$r \times r \times 3.14 =$$

$$2'' \times 2'' \times 3.14 = 12.56sq''$$

**Ellipse**

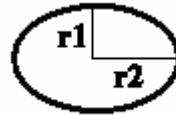

$$r1 \times r2 \times 3.14 =$$

$$2'' \times 3'' \times 3.14 = 18.84sq''$$

**Triangle**

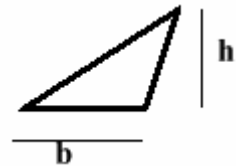

$$b \times h \div 2 =$$

$$3'' \times 2.5'' \div 2 = 3.75sq''$$

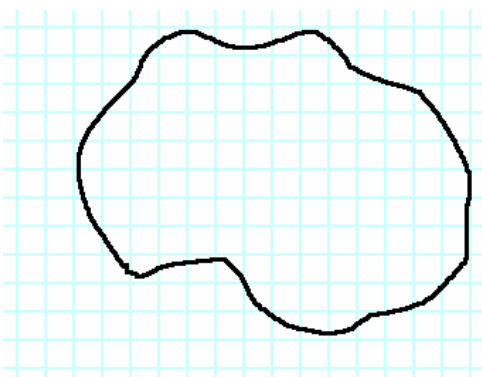

To effectively work out a complex surface area, as shown left. Simply place an imaginary grid of 1" squares over the part, and count the whole squares. Then go around the perimeter and add up all the squares that are more than 1/2 full. Divide the total by 2 and add this to your total of completely filled squares.

**CALCULATING AREA OF THREE DIMENSIONAL OBJECTS**

**Cube**

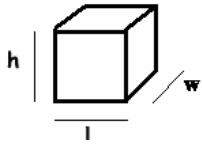

$h \times l \times 6 =$

$2'' \times 2'' \times 6 = 24\text{sq}''$

**Brick**

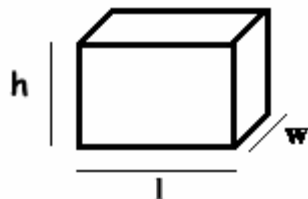

$(2 \times h \times l) + (2 \times l \times w) + (2 \times h \times w) =$

$(2 \times 2'' \times 3'') + (2 \times 3'' \times 1'') + (2 \times 2'' \times 1'') = 12 + 6 + 4 = 22 \text{ sq}''$

**Sphere**

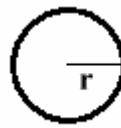

$4 \times r \times r \times 3.14 =$   
 $4 \times 2'' \times 2'' \times 3.14 = 50.24\text{sq}''$

**Egg**

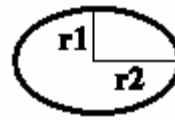

$4 \times r1 \times r2 \times 3.14 =$   
 $4 \times 2'' \times 3'' \times 3.14 = 75.36\text{sq}''$

**Pyramid**



Calculate each side like a triangle, add all sides together. Add base

**Tube**

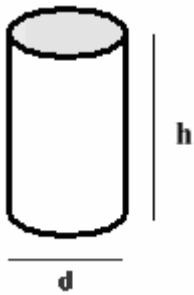

$2 \times 3.14 \times 0.5 \times d \times h =$

$2 \times 3.14 \times 0.5 \times 4'' \times 4'' = 50.24\text{sq}''$

**Solid Rod**

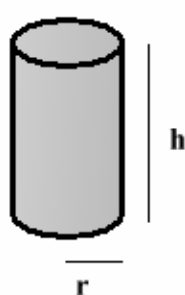

$(2 \times 3.14 \times r \times r) + (2 \times 3.14 \times r \times h)$

$(2 \times 3.14 \times 2'' \times 2'') + (2 \times 3.14 \times 2'' \times 4'') = 25.12 + 50.24 = 75.36 \text{ sq}''$

**CALCULATING THE SURFACE AREA OF BOLTS**

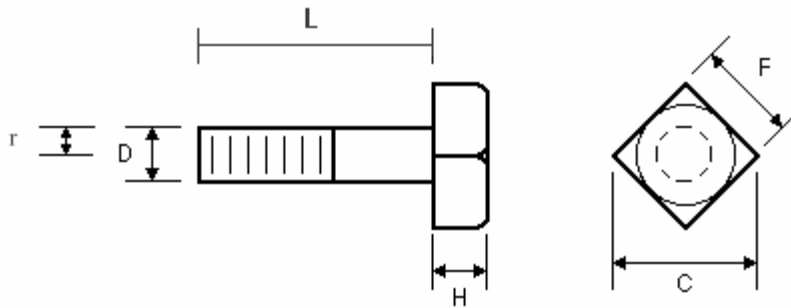

There are 3 dimensions we need to calculate on a bolt. In this exercise, ignore the threads, and consider this area to be a cylinder

1. The shank.
2. The flats or sides of the head
3. The top of the head.

To calculate the shank of the bolt: regard it as a tube

Therefore  $2 \times 3.14 \times r \times L$  (see tube above)

**In this example, there are 4 sides, or 'flats' to the head of the bolt.**

(Some bolts have 6 sides, so, in that situation, you need to use  $D \times H \times 6$ )

Measure each 'flat's' surface area and multiply that answer by the number of flats.

Therefore  $D \times H \times 4$

To quickly calculate the surface area of the head, the bottom of the bolt and the underside of the head, calculate the area of the top as a square, multiply by two and then subtract the area of the bottom of the shank.

$(F \times F \times 2) - (3.14 \times r \times r)$

Your final total calculations are:

$D \times H \times 4 + (F \times F \times 2) - (3.14 \times r \times r) + 2 \times 3.14 \times r \times L = \text{total surface area of bolt}$

These figures are only guides, designed for approximate, quick calculations.

## THE WHEEL CHROMING KIT

The Caswell Wheel Chroming Kit is a 35 Gallon Plating System designed to plate wheels with our Copy Chrome™ plating system. The kit includes:

- 1 Degreasing tank (Size: 12" Width x 24" Length x 24" Height)
- 1 Zincate tank (Size: 12" Width x 24" Length x 24" Height)
- 1 Flash Copper™ Plating Tank (Size: 18" Width x 24" Length x 24" Height)
- 1 Copy Chrome™ tank (Size: 18" Width x 24" Length x 24" Height)
- 2 x Clepco Quickplug 1000W Titanium Heaters, 110V with Thermal Fuse Protection, Digital Control Box and EZ Clip
- 1 x Clepco Quickplug 1000W Stainless Steel Heater, 110V with Thermal Fuse Protection, Digital Control Box and EZ Clip
- 2 Rinse Tanks (Size: 12" Width x 24" Length x 12" Height)
- 2 Copy Chrome™ Anodes (18" x 18")
- 2 Copper Anodes (18" x 18")
- FLASH COPPER™ concentrate makes 35 Gals
- COPY CHROME™ concentrate makes 35 Gals
- SP Degreaser concentrate makes 20 Gals
- Zincate concentrate makes 20 gals
- 1 x 60 amp Rectifier 110 volts
- The Caswell Plating Manual

### Setup

Identify and separate the different tanks. The two largest tanks are for your Flash Copper and Copy Chrome plating. The two smallest tanks are for rinsing. The two intermediate tanks are for the zincate and degreaser chemicals. With a permanent marker, write the chemical name on the outside of each tank.

Identify the heaters. The two titanium heaters are for your two plating tanks. The stainless heater is for your degreaser tank. Install the heaters per the instructions. Remember that low liquid level will cause the heater to overheat and blow the fuse, and could permanently damage the heater. Damage caused by low liquid level is not covered under the heater warranty.

Build and install an agitation system for the two plating tanks. Proper agitation is required for good plating results. Do not skip this step to save time, as you will have problems with your plating, and will have to drain the tanks to install an agitation system. One method for agitating the tanks is to construct a grid out of PVC pipe in the bottom of the tanks. Drill small holes into the top of the pipe to allow air to escape. Use a small air compressor to blow FILTERED compressed air into the tank during plating. Glue the pipes to the bottom of the tank.



### **Mix the Flash Copper Chemicals**

You were shipped:

1. 12 Gallons of Flash Copper A
2. 3 Gallons of Flash Copper B
3. 3 Gallons of Flash Copper C

Add these chemicals to your Flash Copper Plating Tank, then add 16 gallons of DISTILLED WATER. With a permanent marker, mark the liquid level on the outside of the tank. Always top up your tanks with DISTILLED WATER back to the original liquid level. Turn on your agitation to mix the chemicals. Ensure your heater is installed deep enough in the liquid.

### **Mix The Copy Chrome Chemicals**

You were shipped:

1. 70 lbs of Copy Chrome Crystals
2. 192 oz of Copy Chrome Brightener

Add 35 gallons of DISTILLED WATER to your Copy Chrome Plating tank. Turn on the air agitation system and slowly add the 70 lbs of Copy Chrome Crystals to the water. Add the brightener. With a permanent marker, mark the liquid level on the outside of the tank. Always top up your tanks with DISTILLED WATER back to the original liquid level. Ensure your heater is installed deep enough in the liquid. Turn on the heater and bring the solution to 100F. Allow the solution to age for 24 hours prior to use.

### **Mix The Degreaser**

You were shipped 10 lbs of degreaser chemical. Add 20 gallons of DISTILLED WATER to the degreaser tank (30 Gal Tank). Add the degreaser chemical. You may add up to 5 more gallons of water if you desire the liquid level to be higher. With a permanent marker, mark the liquid level on the outside of the tank. Always top up your tanks with DISTILLED WATER back to the original liquid level. Ensure your heater is installed deep enough in the liquid. Turn on the heater and bring the solution to 200F. Stir the solution well to completely dissolve the crystals. Allow the solution to age for 24 hours prior to use.

### **Mix The Zincate**

You were shipped 5 gals of Zincate Concentrate. Add 15 gallons of DISTILLED WATER to the Zincate tank (30 Gal Tank). Put on rubber gloves and eye protection. Slowly and carefully pour the zincate concentrate into the water. Avoid splashing as the zincate is a corrosive chemical. With a permanent marker, mark the liquid level on the outside of the tank. Always top up your tanks with DISTILLED WATER back to the original liquid level.

### **Fill The Rinse Tanks**

Fill the small rinse tanks with 10 gallons of DISTILLED WATER. Mark one tank Copy Chrome Rinse. Mark the other Flash Copper Rinse. Use this rinse water to top up your Copy Chrome and Flash Copper plating tanks respectively, when required.

### **Install the Anodes**

Install the anodes on the long side of the tank. If you plan on plating smaller items in the tank, you may wish to install one anode on a sliding rod, so that you can move it closer to the smaller pieces.

### **Final Setup**

Read pages 8-24 of this manual for instructions on making a tank bar, wiring parts for plating and power supplies.

## Plating Procedure

To plate an aluminum wheel with our Wheel Chroming Kit, the basic procedure is:

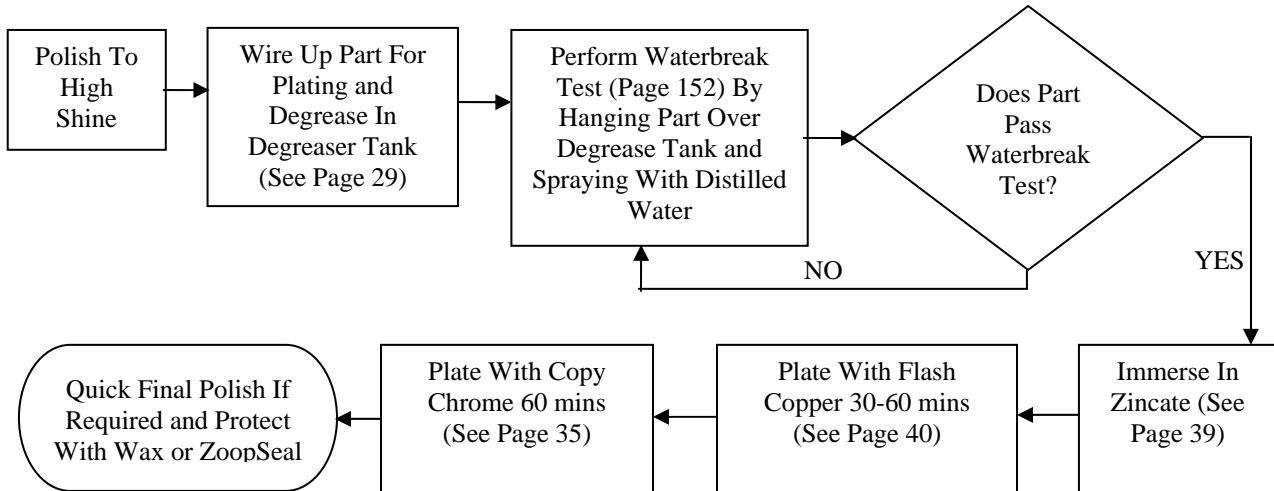

### Additional Tips

Visit our Copy Chrome Forum at <http://forum.caswellplating.com> for additional tips and peer-to-peer technical support when using Copy Chrome plating systems.

24 CT GOLD TANK PLATING .....	108	COPY CHROME .....	5
ACID COPPER PLATE .....	3	COPY CHROME PLATING .....	35
ACID COPPER PLATING .....	43	CURRENT DENSITIES .....	63
ACID PICKLES .....	30	CYANIDE .....	142
AIR EMISSIONS FROM CHROMIUM ELECTROPLATING AND ANODIZING TANKS .....	150	CYANIDE COPPER .....	3
AIR SCRUBBER UNIT .....	10	DECORATIVE CHROME SYSTEM .....	50
ALUMINUM DEOXIDIZER .....	116	DECORATIVE CHROMIUM PLATING .....	50
ANODE POSITIONING .....	12	DEEP RECESS DIES .....	66
ANODIZE DYING TECHNIQUE .....	122	DEFECTIVE SURFACES .....	56
ANODIZING ALUMINUM .....	112	DE-PLATING TANKS .....	13
ANODIZING SEALANT .....	123	DEPOSIT LOCATION CONTROL .....	80
ANODIZING SEALANT LT .....	124	DIP PLATING WITH PLUGNPLATE .....	130
ANODIZING THE PART .....	116	DISPOSAL OF ACID BATHS .....	149
ANTIQUING OXIDIZERS .....	143	DISPOSAL OF BLACK KROME PLATING SOLUTION .....	92
BATTERIES .....	114	DISPOSAL OF BRONZE PLATING SOLUTION .....	48
BATTERY CHARGERS .....	114	DISPOSAL OF CHEMICALS .....	5
BLACK KROME PLATING .....	92	DISPOSAL OF CHROMIUM SOLUTION .....	148
BLACK OXIDE CONCENTRATE .....	141	DISPOSAL OF COPPER PLATING SOLUTION .....	147
BLACK OXIDIZING OF STEEL .....	141	DISPOSAL OF ELECTROLESS NICKEL, KROME & POT METAL PLATING SOLUTION .....	148
BORON NITRIDE ELECTROLESS NICKEL .....	138	DISPOSAL OF SLUDGE, WASTE CONCENTRATE .....	149
BRASS PLATING .....	94	DYING .....	117
BRIGHT ACID COPPER PLATING .....	43	DYING THE ANODIZE .....	118
BRIGHT DIP .....	103	ELECTROCLEANER .....	29
BRIGHT NICKEL PLATING .....	35	ELECTROCLEANING .....	29
BRITEX WHEEL .....	98	ELECTROLESS NICKEL & KROME PLATING .....	133
BRONZE PLATING TROUBLESHOOTING .....	48	ELECTROLESS NICKEL PLATING TROUBLESHOOTING ...	135, 140
BRONZE & BLACKENING SOLUTION .....	143	ENVIRONMENTAL PROTECTION AGENCY .....	147
BRONZE PLATING .....	46	EPA .....	147
BRONZING BABY SHOES .....	145	EPA REGULATION .....	150
BRUSH PLATING .....	4	ESTIMATING PLATE THICKNESS .....	18
BRUSH PLATING WITH PLUGNPLATE .....	128	EXHAUST REQUIREMENTS .....	62
BUS BARS .....	9, 10	FADE ANODIZING .....	1, 120
CADMIUM PLATE .....	101	FASTGOLD .....	132
CALCULATING AREA OF THREE DIMENSIONAL OBJECTS .....	154	FILLING PITS USING SOLDER .....	25
CALCULATING SURFACE AREAS FOR ELECTROPLATING PURPOSES .....	153	FILTER-AGITATOR PUMP .....	10
CALCULATING THE SURFACE AREA OF BOLTS	154	FIXING (OR SEALING) .....	117
CATHODE LEADS .....	78	FLASH COPPER PLATING .....	40
CAUSTIC ETCH .....	116	FLASH COPPER PLATING TROUBLESHOOTING .....	42
CHOCOLATE BROWN .....	143	FUME CONTROL BALLS .....	149
CHROMATE PROCESSES .....	101	GOLD EMBLEM PLATING .....	129
CHROME ANODES .....	11	GOLD PLATING TROUBLESHOOTING .....	109
CHROME NEUTRALIZER KIT .....	5	GP PLATES .....	13
CHROME PLATE .....	3	GRINDING AND LAPPING .....	85
CHROME PLATING .....	49	HARD CHROME PLATING INSTRUCTIONS .....	52
CHROME PLATING TROUBLESHOOTING .....	89	HARD CHROME PLATING MULTIPLE PARTS .....	71
CHROMIC ACID FUME EMISSIONS .....	149	HAZARDOUS WASTE PRODUCER .....	147
CLEANING INSTRUCTIONS PRIOR TO PLATING ..	68	HEATING LARGER KITS .....	16
COLOR MIXING .....	121	HEATING THE SOLUTIONS .....	15
COLOR WHEEL .....	118	HIGHLY STRESSED METALS .....	55
CONTROLLING THE POWER (LCD ANODIZING) .....	114	HYDROGEN AND AIR ENTRAPMENT .....	18
COPPER ANODE .....	11	HYDROGEN EMBRITTLEMENT .....	56
COPPER PLATING TROUBLESHOOTING .....	45	HYDROGEN IMPREGNATION .....	56
COPY CAD .....	5	IMMERSION PLATING .....	3
COPY CAD & ZINC BLACKENER .....	103	INSIDE DIAMETER PLATING .....	77
COPY CAD & ZINC PLATING .....	96	INSTALLING THE ANODE/CATHODES .....	11



INSTALLING THE GP PLATES .....	113	PREPARING THE SURFACE .....	26
INSULATING THE PLATING TANKS .....	15	PREPARING YOUR SOLUTIONS .....	28
INTERNAL ANODES WHEN PLATING INSIDE DIAMETERS..	77	PRE-REPAIR HEAT TREATMENT .....	26
INTERRUPTED CHROME PLATING CYCLES .....	86	PROCESS FOR PLATING ALUMINUM.....	39
INTRODUCTION TO PLATING PROCEDURES.....	33	PROTECTING CLEANED SURFACES .....	68
IRIDESCENT YELLOW CHROMATE .....	101	RAIN WATER.....	28
JIG OR FIXTURE FOR PLATING INSIDE DIAMETERS.....	78	RATE OF DEPOSITION CHART .....	63
LIQUID LEVEL ADJUSTER .....	59	RECYCLING THE RINSE WATER .....	147
MAKING A FUME HOOD.....	9	REMOVAL OF CHROME PLATE.....	87
MAKING UP THE CHROME SOLUTION .....	50	REMOVING DYE.....	123
MAKING UP THE TANKS .....	13	REVERSE OSMOSIS .....	6
MASKING OFF.....	122	RUB ON SILVER PLATING .....	142
METALS CHART .....	33, 34	SAFETY PROCEDURES .....	5
METALX METAL STRIPPERS .....	32	SETTING UP A WORKBENCH.....	9
MIST CONTROL BALLS .....	16	SETTING UP A WORKSHOP.....	8
MIST SUPPRESSANT .....	5	SHALLOW RECESS DIES.....	64
MULTIPLE PARTS PLATING TO NON CRITICAL		SILK SCREEN .....	122
DIMENSIONS.....	72	SILVER NITRATE TECHNIQUE.....	144
MULTIPLE PLATING TO CRITICAL DIMENSION		SILVER TANK PLATING .....	104
TOLERANCES .....	75	SILVERPLATER .....	142
NICHROME POWER CONTROLLER .....	23	SILVERSMITH.....	142
NICKEL & COPY CHROME PLATING TROUBLESHOOTING	37	SODIUM BICARBONATE .....	5
NICKEL ACTIVATOR .....	31	SOME THINGS YOU NEED.....	7
NICKEL ANODE .....	11	SP DEGREASER .....	5, 25, 29
NICKEL CREDIT FORM .....	137	SPUTWELDER.....	18
NICKEL PLATE.....	3	STAINED GLASS OBJECTS.....	146
NICKEL REPLENISHMENT .....	136, 140	STAINLESS STEEL ACTIVATOR.....	40
OLIVE DRAB GREEN CHROMATE.....	102	STAINLESS STEEL ACTIVATOR FOR GOLD .....	110
PENETRATING SEALANT .....	141	STORING CHEMICALS .....	9
PEROXIDING CHROME ANODES. ....	11	STRIPPING THE ANODIZE FILM.....	125
PEWTER BLACKENER.....	143	TANK BAR.....	14
PH TESTER.....	6	TECHNICAL SUPPORT .....	151
PICKLE # 1.....	141	TESTING FOR ANODIZE FILM CONTINUITY .....	125
PICKLE # 4.....	31	THE PRINCIPALS OF PLATING .....	3
PITS.....	25	THE WATER BREAK TEST .....	152
PITTED METALS.....	25	TIFFANY GREEN .....	143
PLASTIC BALLS .....	5	TIN PLATING .....	90
PLATING DRILLS & TAPS .....	69	TITANIUM ANODIZING .....	127
PLATING FLAT PLATES .....	69	TITANIUM GRIPS AND RACKING CLIPS.....	113
PLATING LEAD, PEWTER AND STAINED GLASS		TRIPLE CHROME PLATE.....	3
OBJECTS .....	146	TROUBLESHOOTING ANODIZING .....	126
PLATING LONG OBJECTS .....	13	USE OF CONFORMING ANODES .....	64
PLATING MILLING CUTTERS .....	70	VERDI GREEN .....	143
PLATING PLASTICS & Non CONDUCTIVE MATERIALS ..	144	WASTE DISPOSAL & EMISSIONS .....	147
PLATING TANKS .....	13	WHEEL CHROMING KIT .....	156
PLUMB-LOY .....	25	WIRING UP THE PARTS .....	17
POINTS ABOUT ANODIZED ALUMINUM.....	125	WORONKO PLATING CHAMBER.....	14
POT METAL .....	26, 27	ZINC BRIGHTENER.....	96
PREPARING HARD CHROME SOLUTION.....	61	ZINCATE INSTRUCTIONS.....	39